

# **MODEL OE3001**

## **Optical Chopper**



Copyright © 2017 by SSI.  
All Rights Reserved.

Revision 1.5





# TABLE OF CONTENTS

<b>1. SAFETY WARNINGS</b> .....	<b>1</b>
<b>2. THE OE3001 Overview</b> .....	<b>2</b>
2.1 LCD Display.....	3
2.2 Chopping Head.....	3
2.3 Front Panel and Rear Panel.....	4
<b>3. INSTALL INSTRUCTIONS</b> .....	<b>6</b>
<b>4. BASIC OPERATION</b> .....	<b>7</b>
4.1 Internal Reference Mode.....	7
4.2 External Reference Mode.....	7
4.3 Reference-Out Signal.....	7
<b>5. DETAILED OE3001 OPERATIONS</b> .....	<b>8</b>
5.1 Motor Speed Control .....	8
5.2 Frequency Measurement .....	8
5.3 Frequency Adjustment.....	9
5.4 Frequency Display.....	9
<b>6. REMOTE COMMUNICATIONS</b> .....	<b>10</b>
6.1 Installing the UART to USB Drivers.....	10
6.2 Installing the Software Drivers.....	12
6.3 Installing Software .....	12
6.4 Software Instructions .....	13
6.4.1 Connections between PC and OE3001 .....	13
6.4.2 Parameter Configuration.....	13
6.5 Command Syntax .....	14
6.6 UART Communication.....	16
<b>7. MAINTENANCE AND TROUBLESHOOTING</b> .....	<b>21</b>
7.1 Maintenance .....	21
7.2 Cleaning.....	21
7.3 Troubleshooting .....	21
<b>8. MENU OVERVIEW</b> .....	<b>22</b>
<b>9. SPECIFICATIONS</b> .....	<b>23</b>
<b>10. DRAWINGS</b> .....	<b>25</b>





## 1. SAFETY WARNINGS

Please read the User Manual first before using the OE3001.

- Before the product is delivered to you by express, we will carefully check and confirm it has no mechanical and electric failures. The courier takes all the safety responsibility during the delivery. Please check the OE3001 is not damaged first after unpacking the package and then sign it if no problem.
- The OE3001 operates from a 220V nominal AC power source having a line frequency of 50 Hz.
- The OE3001 must be powered off, unplugged from the AC input power source if it is not used for a long time.
- The OE3001 must be disconnected from all external devices before replacing the fuse. Failure to do so may cause serious injury to the users since high voltages exist within the unit.
- Turn off the OE3001 when connecting it with any external devices.
- Do not move the power line cable when the OE3001 is running.
- Confirm that the OE3001 is installed correctly and the blades are tightly connected to the blade hub before using it.
- Be careful of the rotating blade. Keep hands away while the blade is spinning.
- Please contact us as soon as possible if there is something wrong with the OE3001. Do not disassemble and repair the device by yourself.

## 2. THE OE3001 Overview

The OE3001 optical chopper is a precision instrument utilizing PID algorithm to drive a motor precisely and provide a stable reference output signal. The OE3001 consists of three parts: the OE3001 control box, the OE3001 chopping head and the cable as Fig.1. The control box is like a PID control system to mainly read and control the current spin speed of the electric motor. The chopping head contains a chopper base, some chopper blades and so on. The cable connects the control box and the chopping head.



Fig.1 The OE3001 product.

The OE3001 is set and operated through a 320x240 LCD display and a spin knob. The OE3001 supports different chopping frequency range for different chopper blades. The default 10-slot blade has a frequency range from 20 Hz to 1000 Hz. Other available blades include 2 slots, 6 slots, 15 slots, 30 slots, 60 slots, 100 slots and 5/7 slots. More details on chopper frequency are in Chapter 9 SPECIFICATIONS.

## 2.1 LCD Display

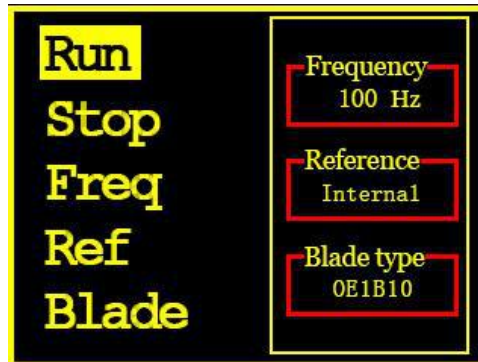

Fig.2 LCD Display.

The main menu of OE3001 is shown in Fig.2. There are five function settings, including [Run], [Stop], [Freq], [Ref] and [Blade].

- Run : start to run the OE3001.
- Stop : stop the OE3001.
- Freq : make a frequency adjustment.
- Reference : choose different reference mode.
- Blade : choose different blade type.

Spin the knob forward and backward to choose the desired setting. Press the knob to enter the corresponding submenu of chosen setting.

## 2.2 Chopping Head

The OE3001 chopping head is made of five parts: a base, a stand, a blade hub, a photoelectric door and a cable connector as Fig.3. The blade hub is used to fix the blade to the chopping head. The photoelectric door measures the spin frequency of the blade. The cable connector is a 6P6C double-ended cable connector. The base is designed for domestic optical platform and can be fixed to 50mm optical platform by M6 screws.

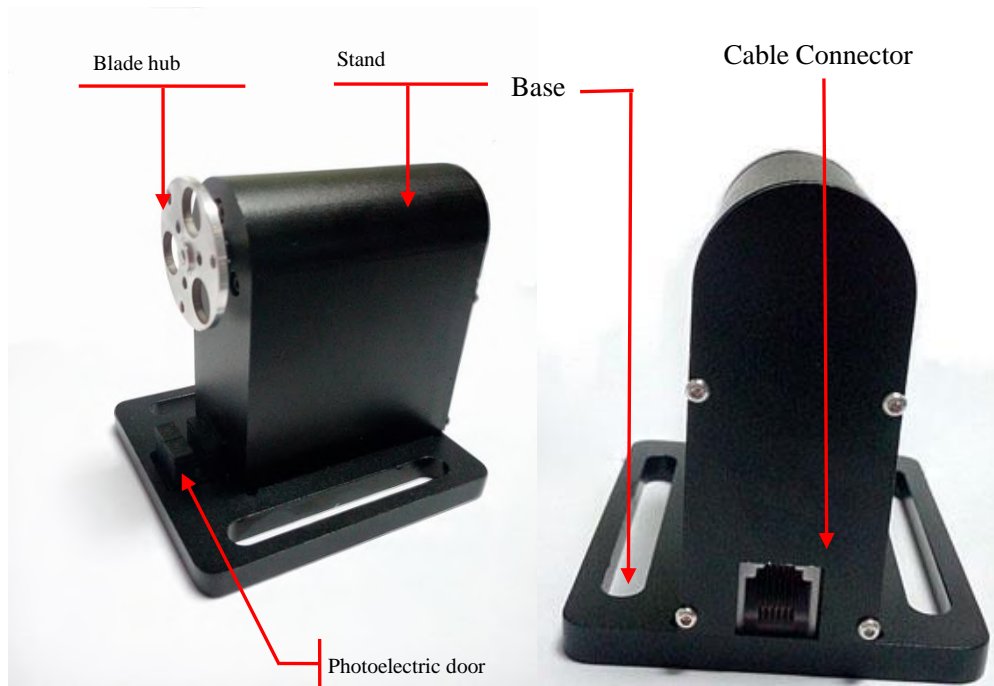

Fig.3 The OE3001 chopping head

### 2.3 Front Panel and Rear Panel

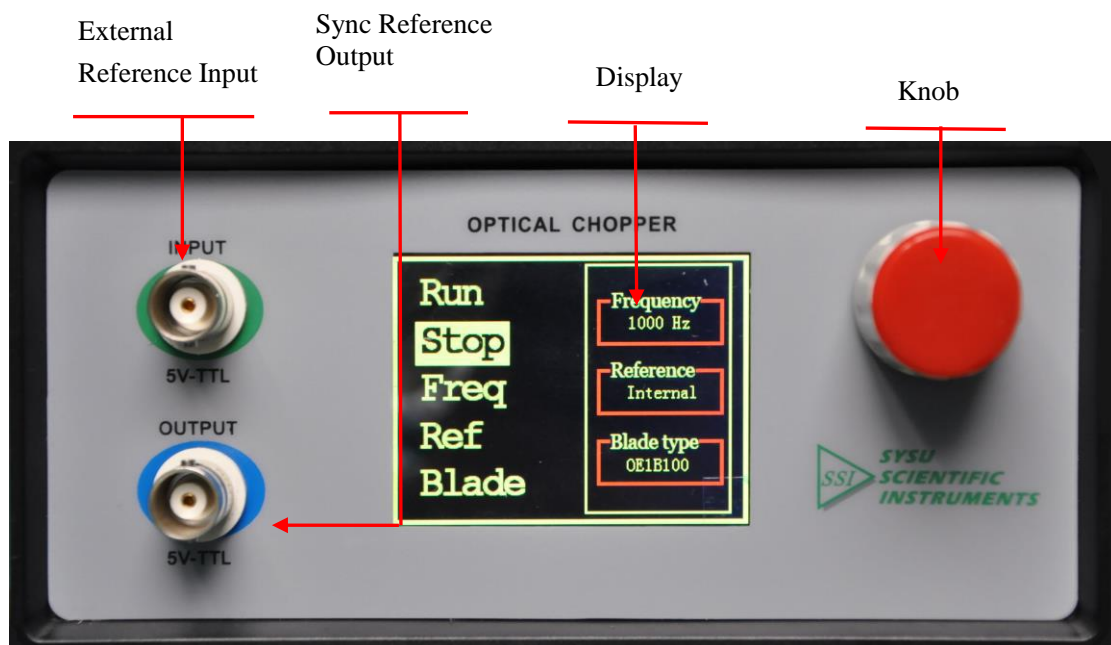

Fig4. Front panel

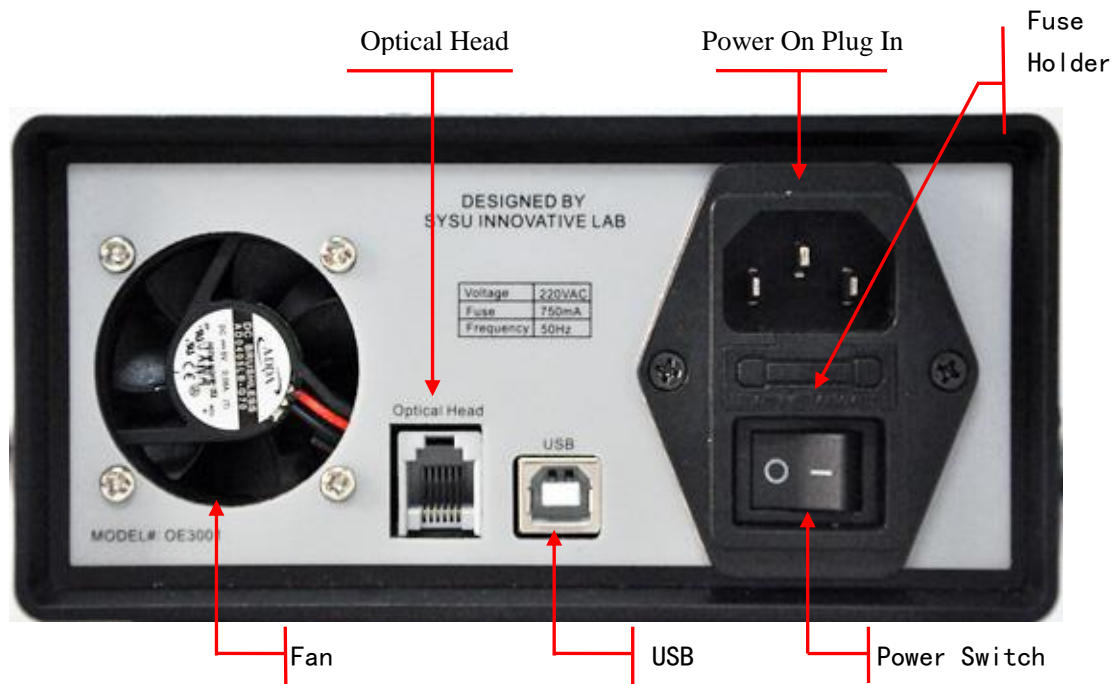

Fig.5 Rear panel

### 3. INSTALL INSTRUCTIONS

1. Carefully unpack the OE3001 control box, chopping head and accessories. See below for a complete list of parts. Please contact us first and do not use the OE3001 if any of the items appear damaged or missing.

Parts List:

---

- OE3001 Control Box
  - OE3001 Optical Chopping Head
  - (1x) 10-slot chopping blade
  - (6x) M3 x 4 Hexagon socket button head screws for blade retention
  - (6x) M3 washers for blade retention
  - M2.5 x 4 set screws for hub retention
  - 5/64" (2.0mm) Alley Key for blade replacement
  - 0.05" (1.27mm) Alley Key for hub alignment
  - 1 meter 6P6C double-ended cable
  - 1 USB Cable
  - 1 BNC Cable
  - 1 Power Supply Line Cord: 110/250 VAC with OE3001
  - (1x) CD.
  - 1 User Manual.
2. Install the blade.
- Lay the chopping head down and put the blade on the blade hub.
  - Make sure the blade do not touch the photoelectric door and spin smoothly. If the blade touch the photoelectric door, adjust the position of the chopper blade hub using the 1.27mm Alley Key until the blade can spin smoothly.
  - Align and fix the blade onto the blade hub using 3 M3\*4 round head hexagon screws and 3 M3 washers.
  - Make sure the blade can spin freely again when the blade is fixed to the chopper blade hub tightly.
3. Use the 6P6C cable to connect the Optical Head on the rear panel of the OE3001 Control Box and the cable connector on the chopping head.
4. Mount the OE3001 Control Box and the OE3001 Optical Chopping Head on a stable surface. Attach the power supply line cord to the OE3001 and plug into an AC outlet. Turn the power switch on and then you can use it.

## 4. BASIC OPERATION

### 4.1 Internal Reference Mode

The OE3001 uses the internal reference mode as the default operation mode where the chopping frequency is set by internal reference signals.

1. Turn the OE3001 power on. The LCD display shows the SSI logo and enters the main menu. By turning the front panel control knob, different menu items can be highlighted. Push the control knob to select the highlighted item.
2. Set the OE3001 parameters to the following for quick internal operation:
  - Ref - Internal
  - Blade- OE1B10
  - Freq - set to the desired frequency
3. Finally, highlight and select "Run" mode. The OE3001 will adjust its speed and lock onto the set frequency automatically.

### 4.2 External Reference Mode

The OE3001 set the chopping frequency by external reference signals in this external reference mode.

1. Attach a TTL or CMOS logic level reference signal to the INPUT BNC on the front panel. Turn the OE3001 power on.
2. Set to the OE3001 parameters to the following for quick external operation:
  - Ref – External
  - Blade - OE1B10
3. Finally, highlight and select "Run" mode. The OE3001 will adjust its speed and lock onto the external reference speed within a few seconds.

### 4.3 Reference-Out Signal

The OE3001 supports sync reference-out signal which has the same frequency and zero phase drift. It is output through the OUTPUT BNC on the front panel.

## 5. DETAILED OE3001 OPERATIONS

### 5.1 Motor Speed Control

The OE3001 adjusts the chopping frequency by changing the motor voltage in internal reference mode and external reference mode. The rated motor voltage range is from 0V to 12V. When the motor voltage direction is proper, the motor will run at a frequency associated with the motor voltage amplitude.

The control module in the OE3001 control box reads the set frequency and sends the corresponding control signal to the ADC module. A proper voltage at the output of the ADC module will be amplified and regulated, and finally acts as the motor voltage to control the motor speed. The larger the motor voltage, the higher the motor speed.

### 5.2 Frequency Measurement

The OE3001 uses two photoelectric doors to detect the spinning speed of the blade. Each photoelectric door has a linear light source and a photoresist. When the blade blocks the light from the linear light source, the photoelectric door outputs a high voltage due to a high resistance of the blocked photoresistor. On the contrast, when the photoresist receives the light from the light source, the photoelectric door outputs a low voltage due to a low resistance of the unblocked photoresistor. When the blade spins steadily, the output voltage is like the figure below:



The output frequency of the photoelectric door is the spinning frequency of the blade. After a schmidt trigger and a phase inverter, the output voltage of the photoelectric door as a feedback signal is sent to the OE3001 control box.

The OE3001 control box uses two timers T1 and T2 to measure the frequency of the feedback signal. The T1 timer is triggered by the rising or falling edge of the signal. The T2 is triggered by a standard periodic pulse signal. When the T1 is triggered by the first edge of the signal at the first time, the T2 starts counting time. The T1 and T2 timers will stop at the same time when the T1 counts up to n. Assuming the T2 gets a certain time length T during the whole counting time, the period of the feedback signal is defined as T/n. Therefore, the frequency is n/T.

## 5.3 Frequency Adjustment

The OE3001 adjusts the spinning frequency of the blade by changing the motor spinning frequency roughly and then subtly.

Every time using a new type of blade, users must choose a proper type of blade at “Blade” menu. Then, the OE3001 will automatically use a motor frequency-voltage formula which is associated with the certain type of the used blade, and get a proper motor voltage according to the set frequency and the formula. Although the rough adjustment can get the set frequency very rapidly, the subtle adjustment is still necessary because such kind of rough adjustment will cause a little frequency offset.

The OE3001 uses PID control algorithm to accomplish the subtle frequency adjustment. The control module compares the set frequency and the measured frequency, and decreases the difference between them to get a steady and precise spinning frequency.

## 5.4 Frequency Display

The OE3001 uses a 320x240 LCD color display to show its menu and data. If the internal reference mode is used, the display will show the internal reference frequency set by users. If the external reference mode is used, the display will show the external reference frequency measured by OE3001.

## 6. REMOTE COMMUNICATIONS

Users can use PC to control OE3001 by commands through USB port. Detailed steps to run a remote communication is as below:

### 6.1 Installing the UART to USB drivers

1. Open the disk and the files inside are as below:

Name	Date modified	Type
OE3001_Console Drivers	8/14/2017 3:50 PM	File folder
OE3001_Console_EN	8/14/2017 3:49 PM	File folder
Uart Assistant	8/14/2017 3:50 PM	File folder
Uart Driver	8/14/2017 3:57 PM	File folder
OE3001_Introduction_EN.pdf	8/2/2016 2:53 PM	Foxit Reader PDF ...
OE3001_Uer_Manual.pdf	8/12/2016 10:08 AM	Foxit Reader PDF ...
readme.txt	7/13/2016 8:53 AM	Text Document

Fig6. CD-ROM files

2. Install UART to USB driver.

a) Open "Uart driver" file as below:

Name	Date modified	Type
Inf installation file	8/14/2017 3:50 PM	File folder
FT232_drive.exe	3/8/2017 2:36 PM	Application
readme.txt	9/22/2014 3:01 PM	Text Document

Fig7. "Uart drive" folder

b) Double click "FT232\_drive.exe" and then you will see the Fig.8 which means the driver is installing.

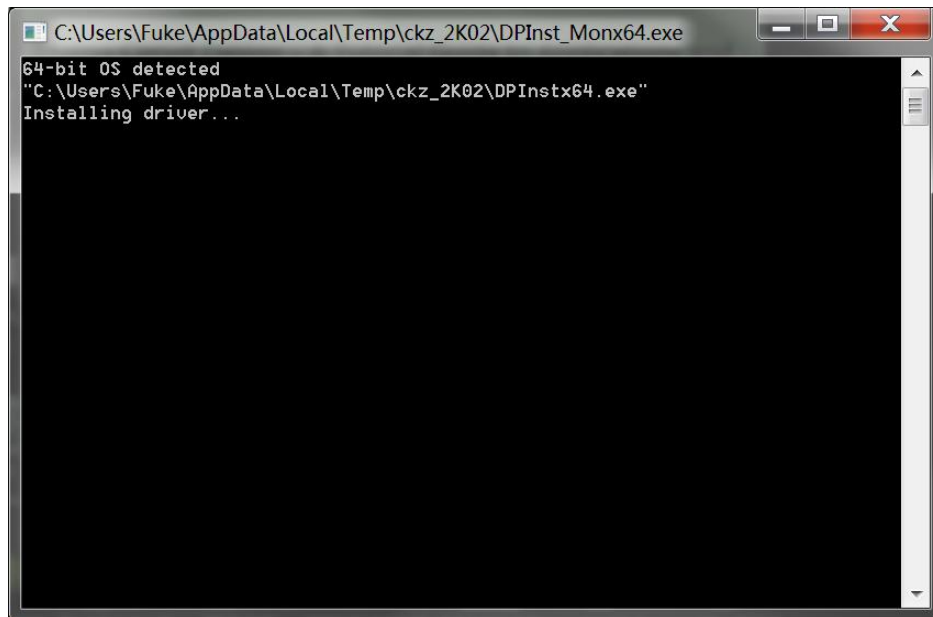

Fig8. USB driver installing interface

c) If the installation is over, then Fig.9 will occur. Press [enter] key to finish it.

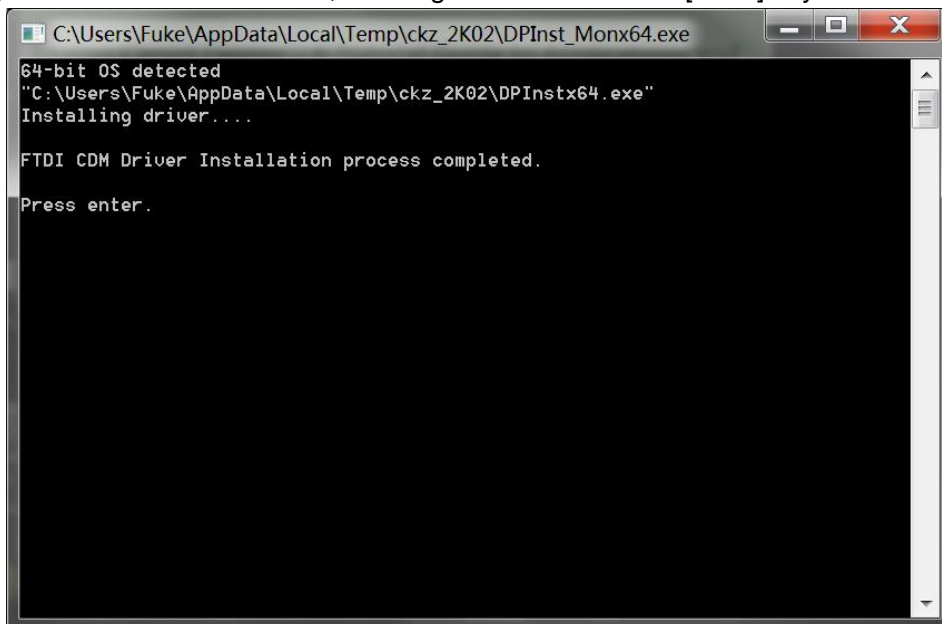

Fig9. USB driver installation process completed

Note that:

1. If the PC is online, the PC will search a proper driver and install it online automatically when the PC is connected with the OE3001 through USB.
2. If the PC has installed the "FT232\_driver.exe", you can skip this step.
3. If the installation fails, please read "readme.txt" and use "Inf installation file" to install the driver again.

## 6.2 Installing the Software Drivers

If the PC hasn't installed NI LabView 2011 or a higher version and a corresponding VISA driver, you need to follow this step to install them all.

1. Open "OE3001\_Console Drivers" folder and its files are as below:

Name	Date modified	Type
bin	8/14/2017 3:49 PM	File folder
license	8/14/2017 3:49 PM	File folder
supportfiles	8/14/2017 3:50 PM	File folder
nidist.id	9/22/2014 4:31 PM	ID File
setup.exe	5/6/2013 5:01 PM	Application
setup.ini	9/22/2014 4:31 PM	Configuration sett...

Fig10. "OE3001\_Console Drivers" folder

2. Double click "setup.exe" file and then install it in default settings.

Note that the PC needs to restart itself to finish the software configuration after the installation succeeds.

## 6.3 Installing Software

If all the former steps succeed, you can start installing the required software in the second file "OE3001\_Console\_EN". This file includes the OE3001 application software which can run in Windows 8/7/XP environment.

1. Open the first file "OE3001\_Console\_EN" and then double click the "OE3001\_Console\_EN.exe". If the former steps succeed, then Fig.11 will occur.

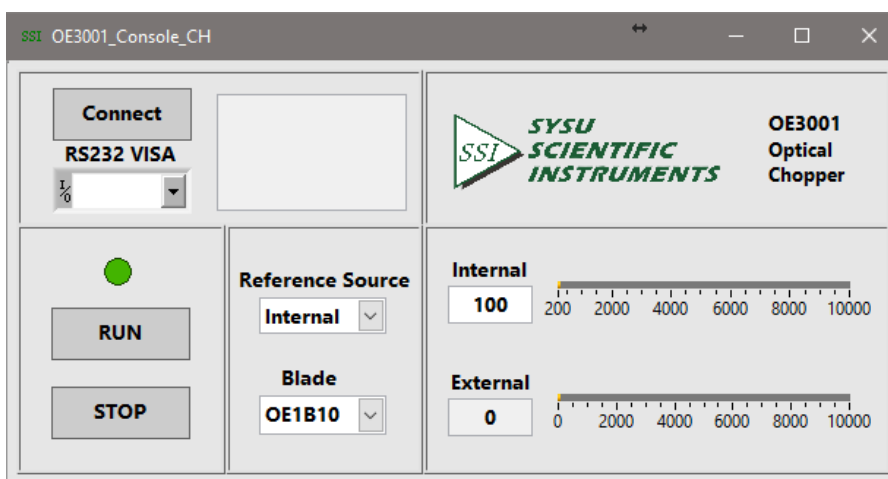

Fig11. OE3001 Software interface

2. Configure the required parameters in the software window.

Note that if the PC has installed NI LabView 2011 or a higher version and a corresponding VISA driver, you can skip chapter 6.2 and configure your OE3001 as the instructions in chapter 6.4.

## 6.4 Software Instructions

### 6.4.1 Connection between PC and OE3001

Before using the software to configure the OE3001, users should connect the PC and the OE3001 successfully.

1. Choose the right COM port at “COM configuration”, and then click “Connect” as Fig.12 (a). If the connection succeeds, the software will show the version information of the OE3001 as Fig.12 (b).

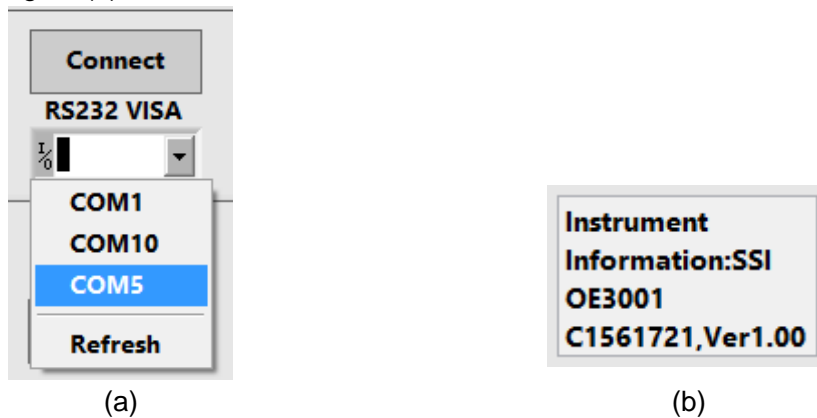

Fig12. Connection steps diagram

2. If the connection fails as Fig.13, please check whether the COM port is correct and then refresh and re-connect it.

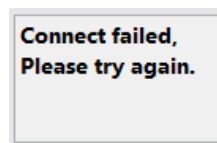

Fig13. Connection error

Note that users can search the COM port at “My Computer/Property/Device Manager/COM and LPT”.

### 6.4.2 Parameters Configuration

1. Choose the reference mode “Internal” or “External”.

- a) If choose “Internal”, users can change the internal reference frequency by filling

in the blank  or pull the progress bar in Fig.14.

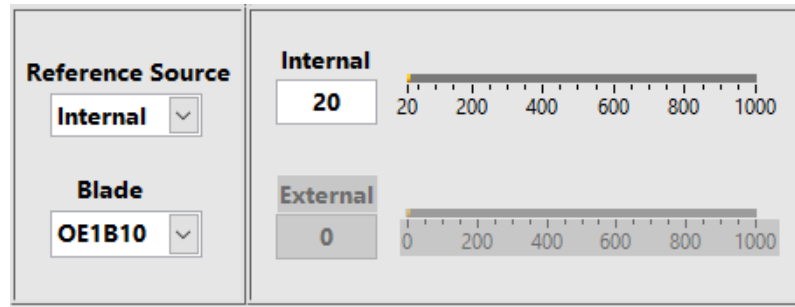

Fig14. Parameters configuration diagram

- b) If choose “External”, users can not decide the external reference frequency. But “External” shows the current external reference frequency at real time.
2. Choose the blade type, such as OE1B10.
  3. Click “RUN” to run the OE3001.

## 6.5 Command Syntax

Computers use ASCII characters to communicate with the OE3001. Commands must be upper case. A command consists of a four-character command mnemonic, arguments if necessary, and a command terminator. The terminator must be a linefeed <lf> or carriage return <cr> on RS232 to USB. No command processing occurs until a command terminator is received.

Multiple commands may be sent on one command line by separating them with semicolons (;). The difference between sending several commands on the same line and sending several independent commands is that when a command line is parsed and executed, the entire line is executed before any other device action proceeds.

OE3001 allows users to query the current value of internal parameters through commands. A query is formed by appending a question mark "?" to the command mnemonic and omitting the desired parameter(s) from the command. Values returned by the OE3001 are sent as a string of ASCII characters terminated by a corresponding terminator. If multiply queries are sent on one command line (separated by semicolons), the answers will be returned individually, each with a terminator.

Table.1 lists all available commands and their corresponding function description.

Table.1 Commands

Command	Syntax	Description
Read Identification	*IDN?	Returns the model number and firmware version
Set Frequency	FREQ=n	Set the desired internal reference frequency
Read Frequency	FREQ?	Returns the internal reference frequency
Set Blade Type	BLAD=n	Set the blade type (n is the number of the blade slot)
Read Blade Type	BLAD?	Returns the blade type
Set Reference Mode	REFE=n	Set the reference mode (0=internal, 1=external)
Read Reference Mode	REFE?	Returns the reference mode
Read External Reference Frequency	INPU?	Returns the current supplied external reference frequency
Start	*STAR	Start to run the blade
Stop	*STOP	Stop to run the blade

## 6.6 UART Communication

This case shows how to remotely run the serial communication. You need an USB cable. The steps are as follows:

1. Use an USB cable to connect the USB of the OE3001 to the USB of the PC.
2. The PC will recognize the USB device and remind to install the driver program. If your PC system is WIN7, the PC will do these automatically online. You just need to wait for a few minutes. If the installation fails, you need to install the driver manually according to Chapter 6.2.
3. Open the folder “Uart Driver” in your disk and double click the file UartAssist.exe. It will call out the software interface, as is shown in Fig.15.

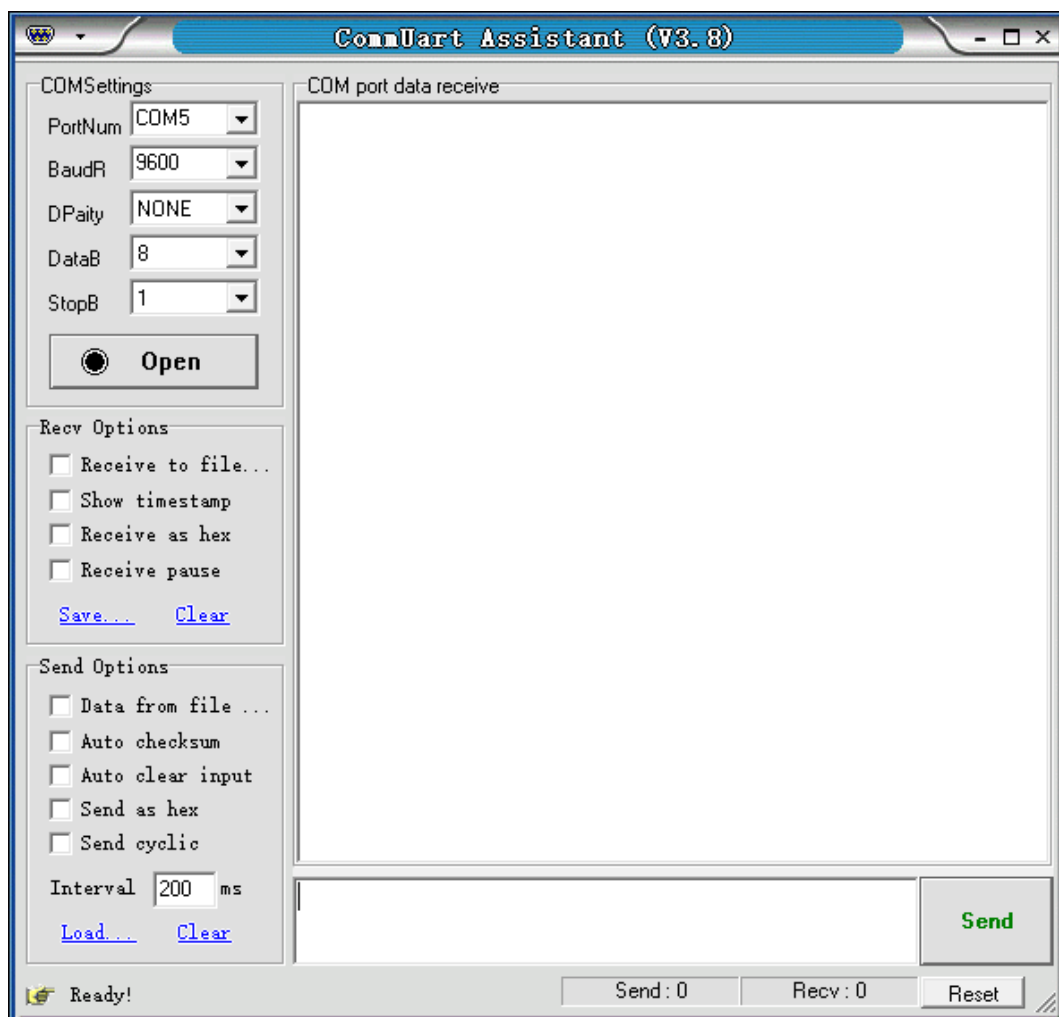

Fig15. Serial debugging assistant interface

Note that this software can set the communication mode, the receiver mode, the transfer mode. The default Baud rate of the OE3001 is 921600. The OE3001 has no parity bit, 8 data bits and 1 stop bit.

Choose “Fixed Byte Checksum” in appendix bits setting as is shown in Fig.16. The value of the fixed byte is 0DH.

The port number choose the COM number automatically assigned by the PC. Users can check it at the ‘COM and LPT’ option in Device Manager of the PC, as is shown in Fig.17.

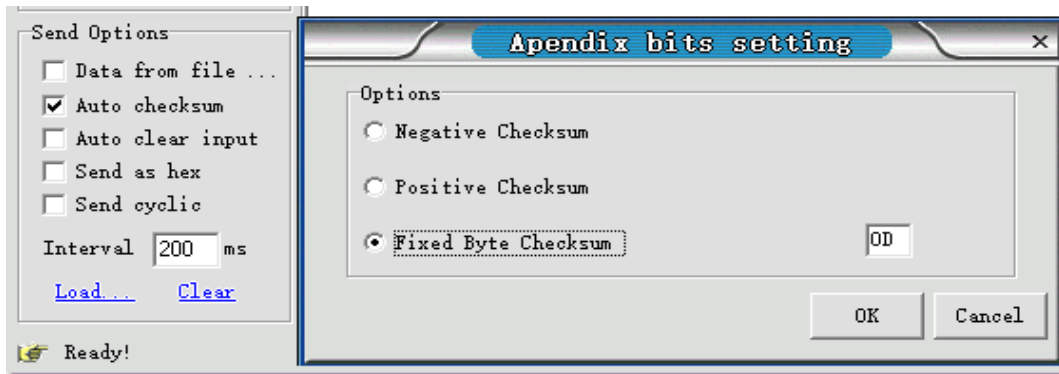

Fig16. Appendix bits setting

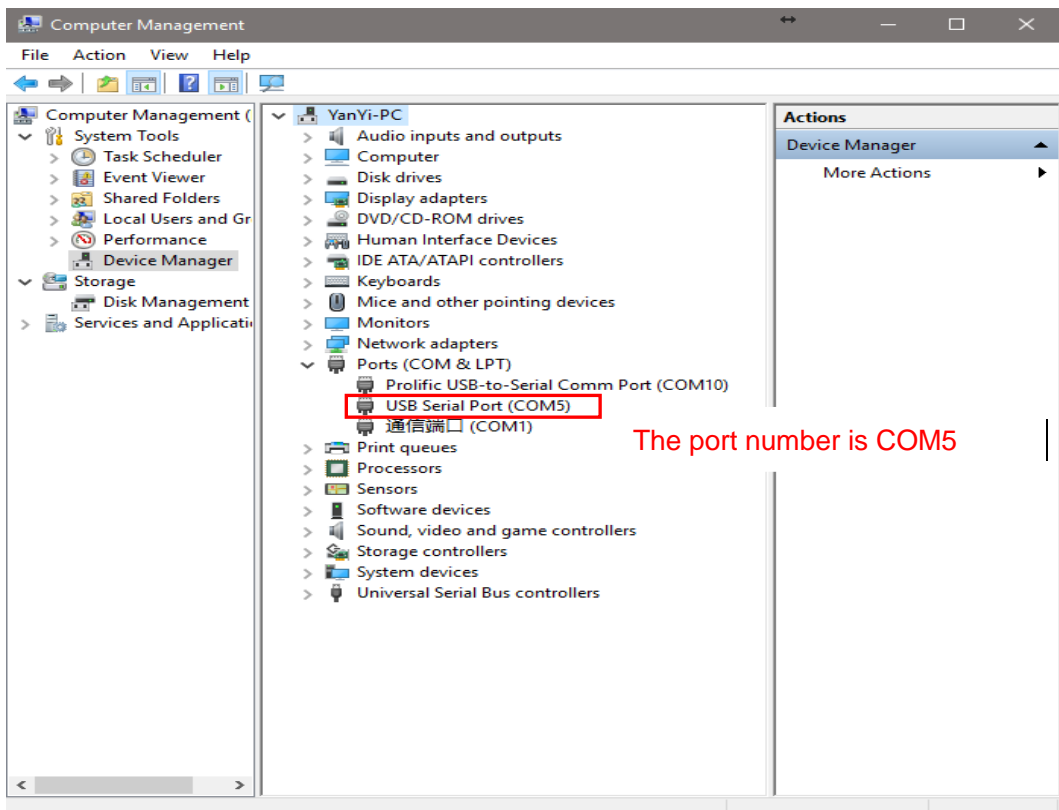



Fig.17 Port number view

After the above settings are completed, click “Open”  and then the communication can be available.

1. Transfer commands to communicate with the OE3001.
  - a) The commands obey the rules described on Chapter 6.5. The real case is shown in Fig.18. Enter commands and then click “Send”. Then the OE3001 will execute the received commands. If the commands query returns, the returned result will be shown in data receive region.

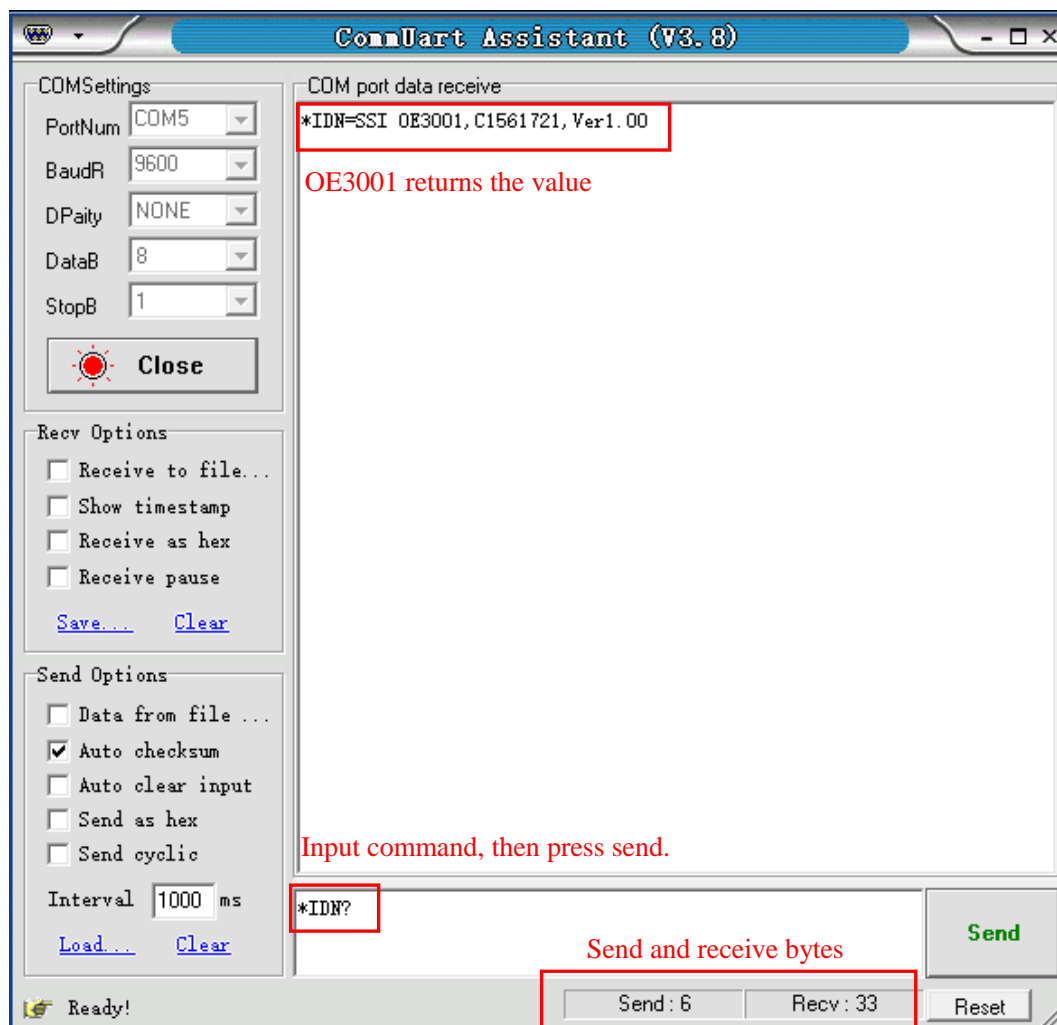

Fig18. Operation example

- b) Multiple commands are separated by semicolons “;”, such as “\*IDN?;FREQ=123;\*STAR;REFE?;FREQ?;\*IDN?” as Fig.19.

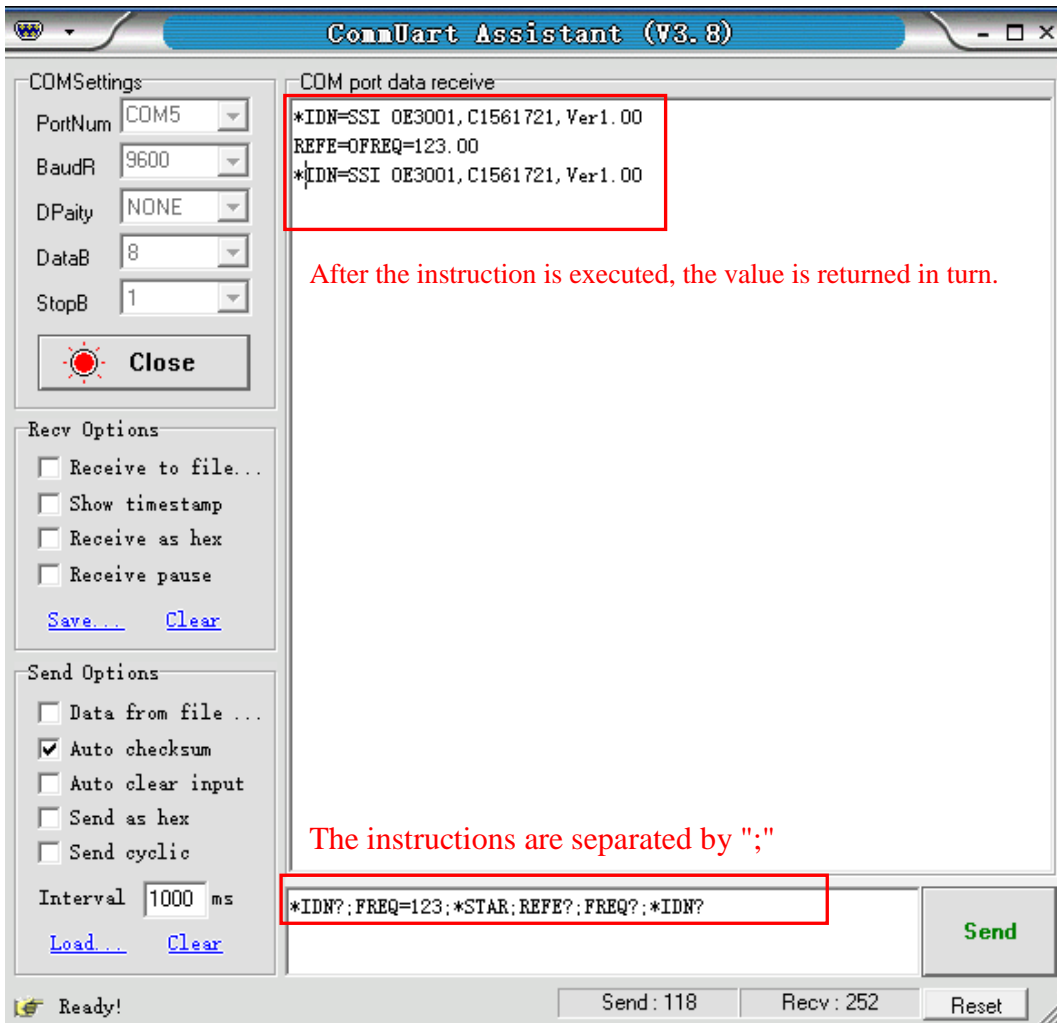

Fig19. The execution of multiple instructions

- c) If users want to execute some commands repeatedly, set “Data Flow Cycle Transfer” on.
  - i. Choose “Send cyclic”.
  - ii. Set “Interval” time.
  - iii. Enter new commands down.
  - iv. Click “Send” to execute the desired commands repeatedly.
  - v. Click “End Send” to end the execution.

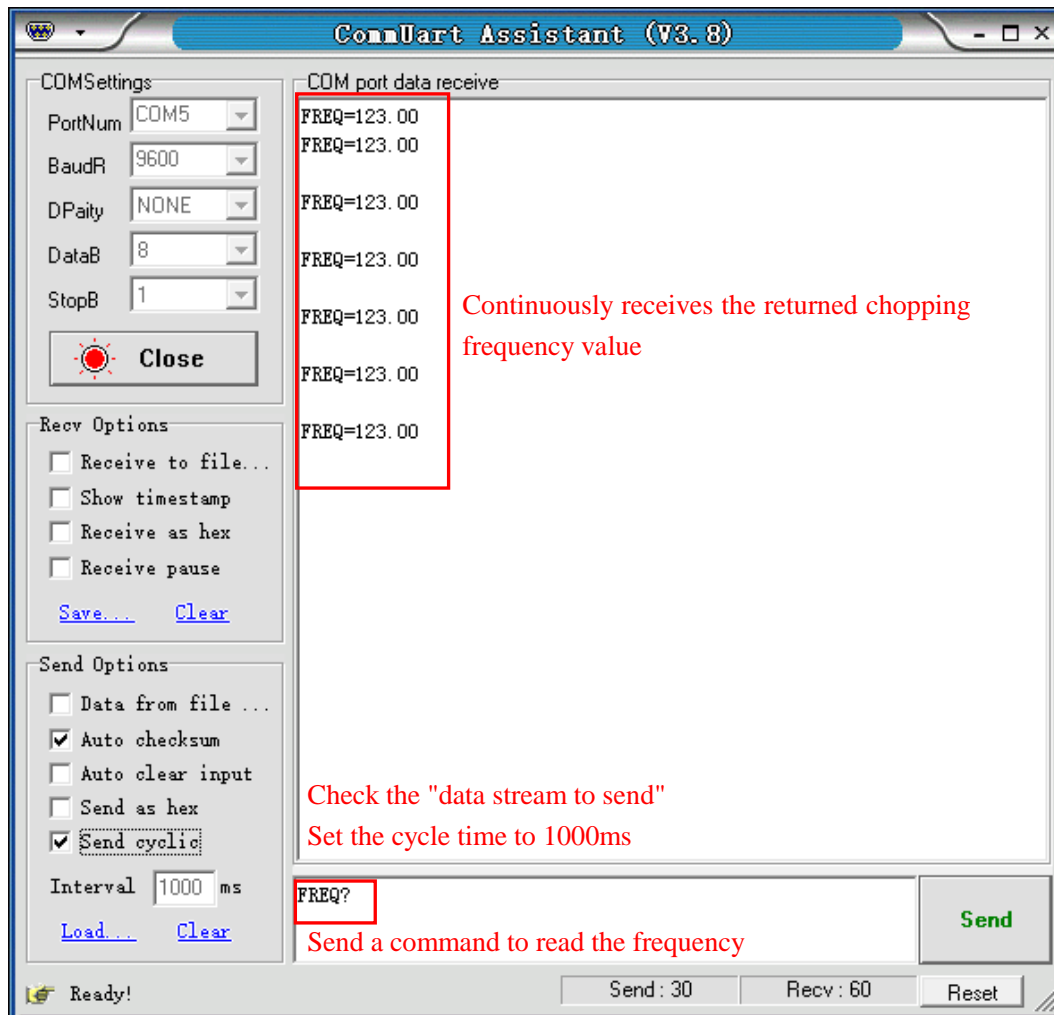

Fig20. Read the chopping frequency continuously

Note that the LCD display will refresh the OE3001 state at the same time when the PC uses “UartAssist.exe” to control the OE3001. The OE3001 can use many other kinds of UART assistant software. All the steps are basically similar.

## 7. MAINTENANCE AND TROUBLESHOOTING

### 7.1 Maintenance

1. The high-precision DC motor used in OE3001 should be turned off to extend its service life when the OE3001 is not used.
2. Do not touch the spinning blade by hands or other things. Otherwise, the blade will be damaged and deformed. Beside, do not plug the blade in or off when the OE3001 powers on.
3. Do not block the fan on the rear panel when the OE3001 is running.
4. Please use the OE3001 in a dry and clean environment.

### 7.2 Cleaning

1. The OE3001 should only be cleaned with a soft cloth and mild soap detergent. Do not use a solvent-based cleaner.
2. If the chopping blade need to be cleaned due to a dust-covered surface, please remove it from the chopping head first, lay it on a clean platform, and then wipe it clean with a soft cloth. Besides, using a lubricating rust inhibitor to wipe the blade can prevent it from rusting in a high humidity environment.

### 7.3 Troubleshooting

1. If the reference output frequency cannot lock to the setting frequency, please check whether choose the proper blade type.
2. When in external reference mode:
  - a) If the screen shows “No Signal”, it indicates that the external signal is not correctly connected.
  - b) If the blade stops suddenly, please check whether the external reference frequency exceeds the available range.
  - c) If the sync reference output goes wrong, please check whether the amplitude and frequency of the external input signal are in available range.
3. If the blade stops spinning but all operations and settings are correct, please check whether the blade is blocked by obstacles.

## 8. MENU OVERVIEW

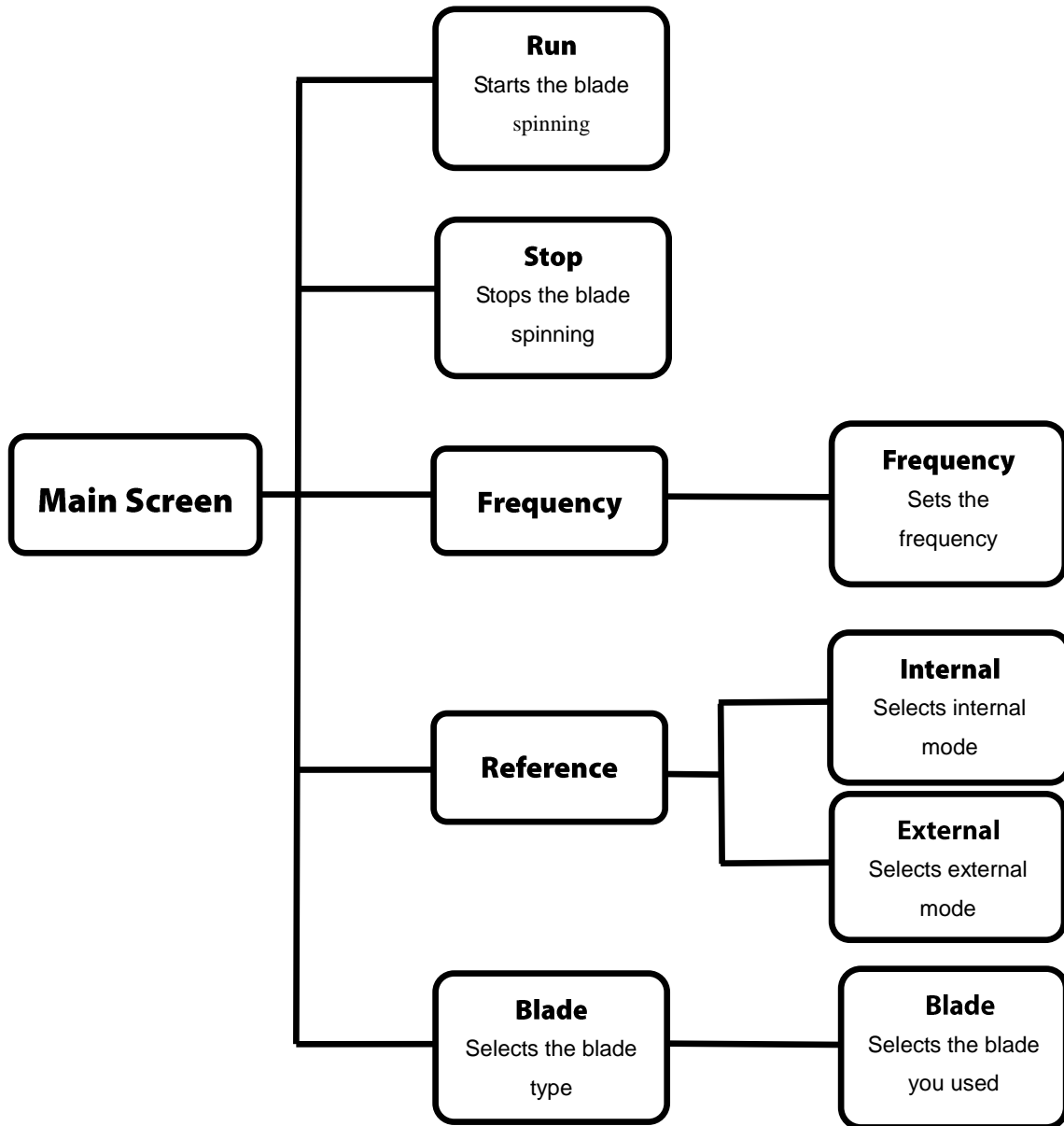

## 9. SPECIFICATIONS

<b>Chopping Frequency</b>	
OE1B2 (2-slot)	1~99 Hz
OE1B10 (10-slot)	20Hz~1 KHz
OE1B15 (15-slot)	30Hz~1.5 KHz
OE1B30 (30-slot)	60Hz~3 KHz
OE1B60 (60-slot)	120Hz~6 KHz
OE1B100 (100-slot)	200~10 KHz
OE1B57 (inside 5-slot, outside 7-slot)	Inner: 10~500 Hz Outer: 14~700 Hz
<b>Input/Output</b>	
Input Compatibility	TTL/CMOS
Input Voltage Range	0~5V
Input High	>3.6V
Input Low	<0.4V
Output Compatibility	TTL/CMOS
Output Voltage Range	0~5V
Minimum Load Impedance (1)	500 $\Omega$
<b>Communication</b>	
Communication Type	USB
Protocol	USB (RS232 Emulation)
Baud Rate	9600
Data Bits	8
Stop Bits	1
Parity	NONE
Handshaking	NONE
<b>Blade Slot Angle</b>	
OE1B2	90°
OE1B10	18°
OE1B15	12°
OE1B30	6°
OE1B60	3°
OE1B100	1.8°
OE1B57	36° Inner, 25.7° Outer

<b>Chassis Features</b>	
Dimensions (W x H x D)	206mm*150mm*70mm (81.1"x59.0"x27.6")
Input and Output Connectors	BNC
Menu Control	Optical Encoder (Control Knob)
Operating Temperature	10-40°C
Display Type	320x240 Pixel LCD Display
Frequency Resolution	0.01Hz
<b>Power Supply</b>	
Supply Type	Linear
Input Voltage	110/250 VAC
Power Frequency	50Hz $\pm$ 0.2Hz
Input Power	30 W MAX
Fuse Ratings	750mA
Fuse Size	5x20mm

(1) The minimum load impedance represents the minimum allowable terminal resistance. A lower practical load impedance will cause the short circuit. In this case, it may cause circuit degradation and eventual circuit failure.

10. DRAWINGS

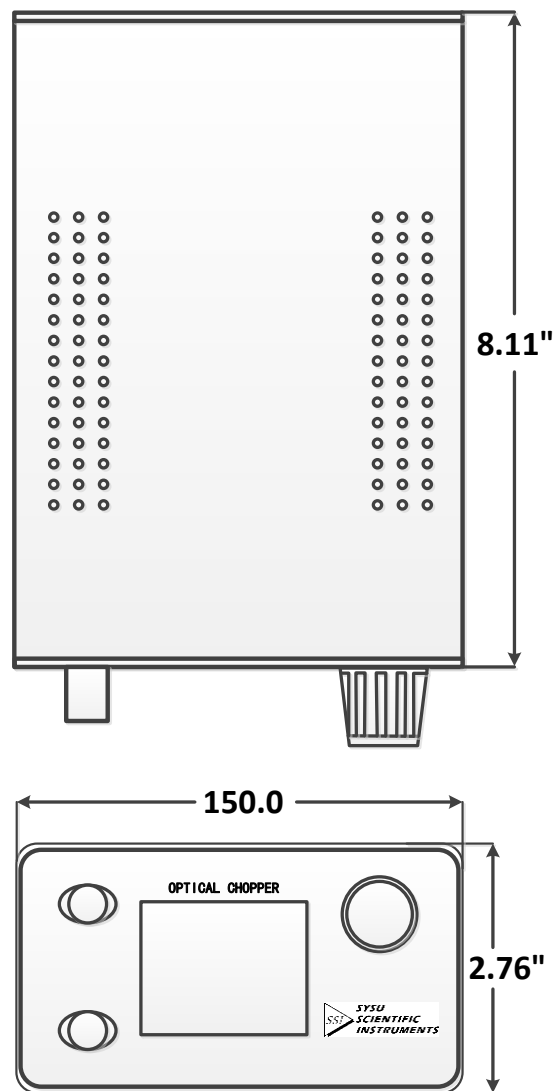

Fig21. Chopper main chassis dimensions

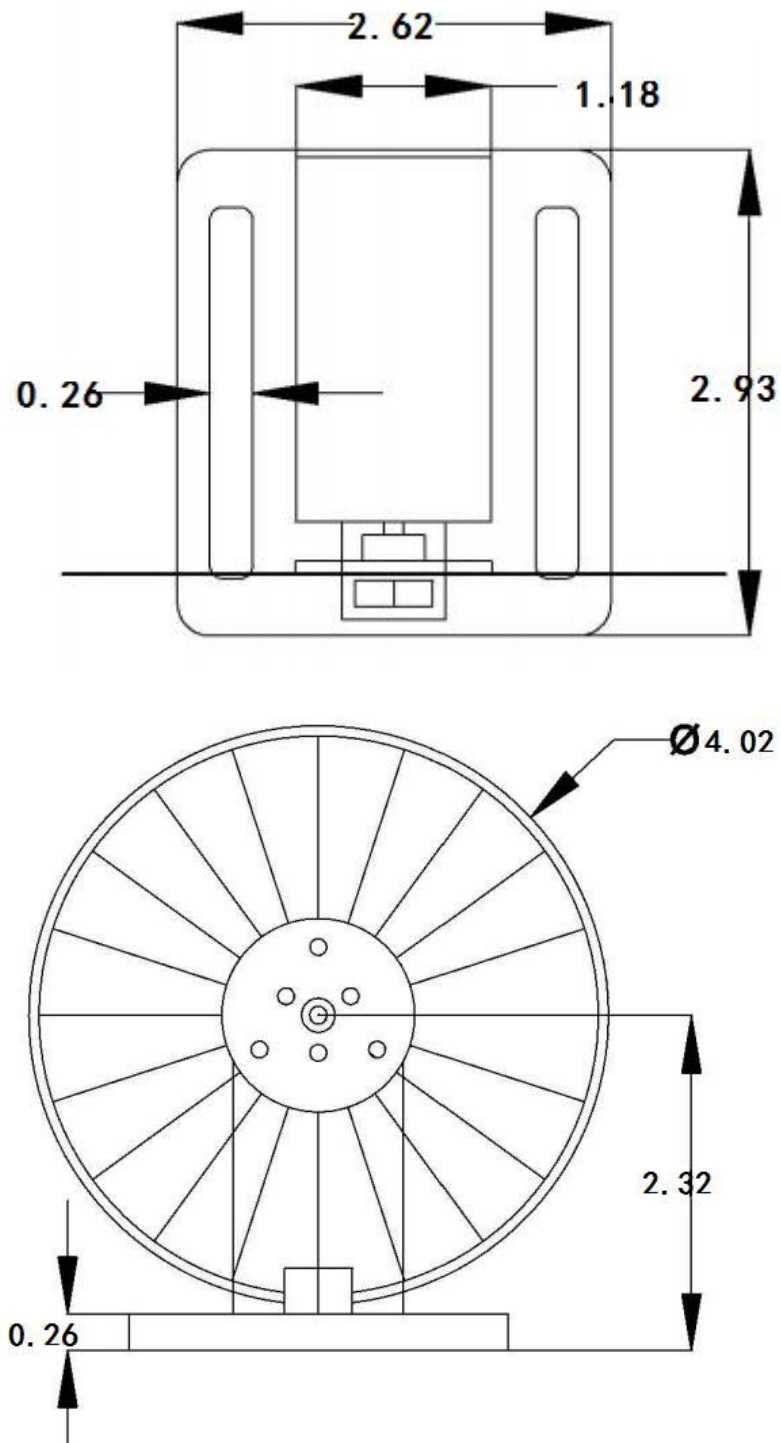

Fig22. Chopper mechanical dimensions

Note that the unit is in millimeter.