

MODEL OE1022

DSP Lock-In Amplifier



Copyright © 2017 by SSI.
All Rights Reserved.

Revision 1.3

1. SPECIFICATIONS	1
1.1 Signal Channel.....	1
1.2 Reference Channel	1
1.3 Demodulator	2
1.4 Internal Oscillator	2
1.5 Displays	2
1.6 Outputs	2
1.7 Interface	3
1.8 General.....	3
2. LOCK-IN AMPLIFIER BASICS	4
2.1 Introduction	4
2.2 Functional Diagram	6
2.3 Reference Channel	7
2.4 Phase Sensitive Detectors.....	7
2.5 Time Constants and DC Gain.....	9
2.6 DC Outputs and Scaling.....	11
2.7 Dynamic Reserve	13
2.8 Signal Input Amplifier and Filters	15
2.9 Input Connections.....	17
2.10 Intrinsic Noise Sources.....	18
2.11 External Noise Sources	20
2.12 Aux In/Out	22
2.13 Sweep Frequency and Amplitude of Signal Generator.....	22
2.14 FFT Spectral Analysis.....	23
2.15 Multi-harmonic Detection	23
3. INTERFACES.....	25
3.1 Front Panel	25
3.2 Rear Panel	26
3.3 Main Display	27
3.3.1 Status Bars.....	27
3.3.2 Data Bar.....	28
3.3.3 Monitoring Bar	29
3.3.4 Function Bar.....	30
4. MENUS.....	31
4.1 [INPUT/FILTERS]	31
4.1.1 <Source>: Setting the Input Signal Mode.....	31
4.1.2 < Current Gain >: Setting the Current Gain.....	31
4.1.3 < Grounding >: Setting the Ground Mode.	31

4.1.4 < Coupling >: Setting the Coupling Mode.....	32
4.1.5 <Line Notches>: Setting the Status of the Notch Filters.	32
4.2 [REF/PHASE].....	33
4.2.1 < Ref. Phase >: Setting the Reference Phase.....	34
4.2.2 < Ref. Source>: Setting the Reference Signal Source.....	34
4.2.3 < Ref. Slope>: Setting the External Signal Mode.....	34
4.2.4 < Ref. Frequency>: Setting the Internal Reference Frequency.	35
4.2.5 < Sweep>: Setting the Internal Reference Signal Frequency Sweep.....	35
4.2.6 <Harmonic>: Setting the Harmonic Detection.....	37
4.2.7 <Sine Output>: Setting the Sine Output.....	37
4.3 [GAIN/TC].....	40
4.3.1 <Sensitivity>: Setting the Full Scale Sensitivity.	40
4.3.2 <Reserve>: Setting the Dynamic Reserve.	41
4.3.3 < Time Constants >: Setting the Time Constants.....	41
4.3.4 < Filter db/oct >: Setting the Roll Off Slope of the Low Pass Filter.	41
4.3.5 < Synchronous >: Setting the Status of the Synchronous Filter.	41
4.4 [DISPLAY].....	42
4.4.1 < Monitor >: Setting Status Bar Display.	42
4.4.2 < Display & Scale >: Setting the Dynamic Area Display	43
4.4.3 < Equation >: Setting the Equation.....	46
4.4.4 < Disp More >: More Display Settings.....	47
4.5 [SAVE/RECALL].....	48
4.6 [CHANNEL OUTPUT].....	49
4.6.1 < Output Source >: Setting Output Source.....	50
4.6.2 < Offset&Expand >: Setting the Offset and Expand.....	51
4.6.3 < Speed >: Setting the Output Speed.....	51
4.7 [SAMPLE].....	51
4.7.1 < Step Time >: Setting the Sampling Step Time.....	52
4.7.2 < Length >: Setting the Sampling Length.	52
4.7.3 < Select >: Setting the Sampling Object.....	52
4.7.4 < Trigger Mode >: Setting the Trigger Mode.	53
4.7.5 < Sample Mode >: Setting the Sampling Mode.....	53
4.8 [AUX OUTPUT].....	53
4.9 [SYSTEM].....	54
4.9.1 < Info >: Setting the Parity Mode.....	54
4.9.2 < Screen > Submenu.....	56
4.9.3 < RS232 >: Setting the RS232 Mode.....	57

4.9.4 <Reset? >: Reset the Lock-In Amplifier.....	58
4.10 [AUTO SET].....	58
4.10.1 < Auto Reserve >: Setting the Dynamic Reserve Automatically.	58
4.10.2 < Auto Gain >: Setting the Sensitivity Automatically.	58
4.10.3 < Auto Phase >: Setting the Phase Shift Automatically.	59
4.10.4 < Auto Scale >: Setting the Scale Automatically.....	59
4.11 [CONTROL].....	59
4.11.1 < Start/Cont >: Start or Continue Sampling.....	59
4.11.2 < Pause/Clear >: Pause Sampling Or Clear Sampling Data.	59
4.11.3 < Cursor >: Display or Hide the Cursor In <Chart> Map.....	60
4.11.4 < Active Chart >: Choose the <Chart> as the Active Area.....	60
5. REMOTE PROGRAMMING.....	60
5.1 OE1022 Command Syntax	60
5.2 Detailed Command List	61
5.2.1 Reference and Phase Commands	61
5.2.2 Equation Commands	64
5.2.3 Input and Filter Commands	65
5.2.4 Sensitivity and Time Constants Commands	65
5.2.5 Display and Output Commands.....	66
5.2.6 Save and Read Settings Commands	68
5.2.7 Auto Set Commands.....	68
5.2.8 Data Storage Commands	69
5.2.9 Data Read Commands.....	70
5.2.10 Reset and IDN Commands	72
6. COMPUTER OPERATION.....	73
6.1 Install Software.....	73
6.2 How to Use the Software.....	76
6.2.1 Begin to Run	76
6.2.2 Connection	76
6.2.3 Input Configuration.....	78
6.2.4 Reference and Frequency Sweep Configuration	80
6.2.5 Dynamic Reserve and Sensitivity Configuration.....	82
6.2.6 Harmonic Configuration	83
6.2.7 Filter Configuration.....	84
6.2.8 Output Configuration	85
6.2.9 Aux Output Configuration.....	86
6.2.10 Custom Equation Configuration	87
6.2.11 Sine Output Configuration	88

6.2.12 Data Buffer Configuration	89
6.2.13 Data Storage.....	91
6.2.14 Display Harmonic Waveform	92
6.3 Usage Examples.....	93
7. PERFORMANCE TESTS.....	101
7.1 Self-Test	103
7.2 DC Offset.....	103
7.3 Common Mode Rejection.....	104
7.4 Amplitude Accuracy and Flatness.....	105
7.5 Amplitude Linearity	107
7.6 Frequency Accuracy.....	108
7.7 Sine Output Amplitude Accuracy and Flatness	109
7.8 DC Outputs and Inputs	110
7.9 Input Noise.....	111
7.10 OE1022 Performance Test Record	112
8. OPERATION EXAMPLES.....	116
8.1 Simple Signal Measurements.....	116
8.2 Harmonics Measurements	120
8.3 Optical Spectral Measurements.....	124
8.4 Serial Communication.....	126

1. SPECIFICATIONS

1.1 Signal Channel

Voltage Inputs	Single-ended (A) or differential (A-B).
Full Scale Sensitivity	1 nV to 1 V in a 1-2-5 sequence.
Current Input	10^6 or 10^8 V/A.
Input Impedance	
Voltage	10 M Ω //25 pF, AC or DC coupled.
Current	1 k Ω to virtual ground.
CMRR	> 100 dB to 10 kHz, decreasing by 6 dB/oct.
Dynamic Reserve	> 100 dB.
Gain Accuracy	0.2% typ, 1% max.
Noise	
Voltage	6 nV/ $\sqrt{\text{Hz}}$ at 997 Hz.
Current	13 fA/ $\sqrt{\text{Hz}}$ at 997 Hz. 15 fA/ $\sqrt{\text{Hz}}$ at 97 Hz.
Line Filter	50/60 Hz and 100/120 Hz.
Grounding	BNC shields can be grounded or floated via 1 k Ω to ground.
Stability	<5 ppm/ $^{\circ}\text{C}$

1.2 Reference Channel

Input	
Frequency Range	1 mHz to 102 kHz.
Reference Input	TTL or Sine.
Impedance	1 M Ω //25pF.
Phase	
Resolution	0.01 $^{\circ}$
Absolute Phase Error	< 1 $^{\circ}$
Relative Phase Error	< 0.01 $^{\circ}$
Orthogonality	90 $^{\circ}$ \pm 0.001 $^{\circ}$
Phase Noise	
Internal ref.	Synthesized, < 0.0001 $^{\circ}$ rms at 1kHz.
External ref.	0.005 $^{\circ}$ rms at 1kHz (time constant: 100ms, 12 dB/oct).
Drift	< 0.01 $^{\circ}$ / $^{\circ}\text{C}$ below 10 kHz. < 0.1 $^{\circ}$ / $^{\circ}\text{C}$ above 10 kHz.
Harmonic Detection	2F, 3F, ...nF to 120 kHz (n<32,767).
Acquisition Time	
Internal Ref.	Instantaneous acquisition.
External Ref.	(2 cycles + 5 ms) or 40 ms, whichever is greater.

1.3 Demodulator

Stability	
Digital Outputs	No zero drift on all settings.
Displays	No zero drift on all settings.
Analog Outputs	< 5 ppm/°C for all dynamic reserves.
Harmonic Rejection	-90 dB
Time Constants	10 μ s to 3ks (<200Hz); 10 μ s to 30s (>200Hz) (6, 12, 18, 24 dB/oct rolloff).
Synchronous Filter	Available below 200 Hz and 18,24 dB/oct.

1.4 Internal Oscillator

Frequency	
Range	1 mHz to 102 kHz
Accuracy	2 ppm + 10 μ Hz
Resolution	0.1 mHz
Distortion	-80 dBc (f < 10 kHz), -70 dBc (f > 10 kHz)
Amplitude	0.001 to 5 Vrms with 1 mVrms resolution
Error	1%
Temperature Stability	50 ppm/°C
Outputs	Sine, output impedance is 50 Ω .

1.5 Displays

Screen	5.6 inch, 640 \times 480 TFT color LCD
Screen Format	Single or dual channel display.
Display Value	X, Y, R, θ .
Display Types	Large numeric readout, bar graph, polar plot and strip chart.

1.6 Outputs

CH1 and CH2 Outputs	
Function	X, Y, R, θ , harmonic
Amplitude	\pm 10 V
Impedance	100 Ω
AUX Inputs	
Function	Four channels for input.
Amplitude	\pm 10V
Impedance	1M Ω
AUX Outputs	

Function	Four channels for output.
Amplitude	±10V.
Trigger Input	
Function	TTL external trigger for data storage
Monitor Output	
Function	Analog output of signal amplifiers.

1.7 Interface

RS-232 to USB	All instrument functions can be controlled and read through the USB interface.
IEEE-488 interface (optional)	

1.8 General

Power Requirements	
Voltage	110/240 VAC
Frequency	50/60 Hz
Power	40 W
Weight	26.235 lb. (11.9kg)
Dimensions	
Width	18.6 " (473mm)
Depth	19.3 "(490mm)
Height	
With feet	6.3 "(160mm)
Without feet	5.8 "(147mm)

2. LOCK-IN AMPLIFIER BASICS

2.1 Introduction

The Lock-in amplifier is a device used to detect very small signals, which are always obscured by noise sources many thousands of times larger. The lock-in amplifier can extract these small signals from noises and measure their values accurately.

The lock-in amplifier is a weak signal detection method based on the coherence. Lock-in amplifiers use a key technique known as phase-sensitive detection (PSD) to single out the required component of the signal. This component has the same frequency with the reference signal and has a fixed phase differences with the reference signal. Noise signals at other frequencies are rejected and do not affect the measurement.

The basic processing of small signals is amplification. Traditional amplifiers will amplify both the noise signals and the required signals. If there is no band limiting or filtering, amplification will decrease the signal to noise ratio (SNR). Therefore, filtering is needed to purify the signal and increase the SNR in order to measure the weak signal accurately.

PSD can be seen as a band-pass filter with a very narrow bandwidth. The basic modules of PSD include a multiplier module and a low-pass filter (LPF) module, as shown in Fig.1. Sometimes PSD is described as a multiplier module without a LPF.

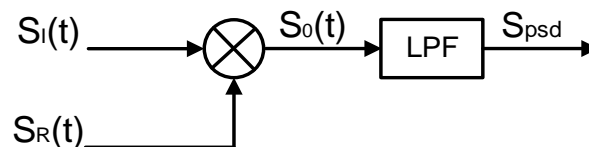

Fig.1 PSD diagram.

In Fig.1, $S_1(t)$ is the input signal plus noise in the time region, $S_R(t)$ is the reference signal, which has a fixed frequency with the test signal.

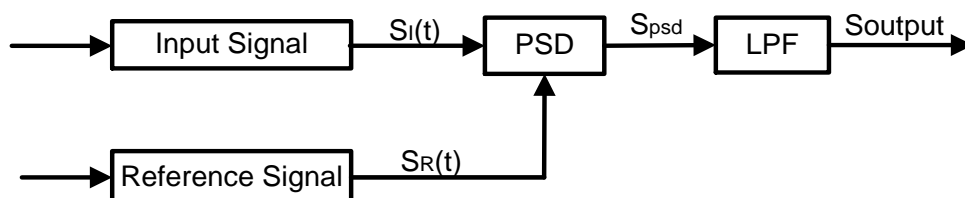

Fig.2 Single-phase amplifier diagram.

In Fig.2, the input signal $S_I(t)$ is defined as: $S_I(t) = A_I \sin(\omega t + \varphi) + B(t)$, where ω is the frequency of input signal, $A_I \sin(\omega t + \varphi)$ is the test signal, $B(t)$ is the total noise.

The reference signal $S_R(t)$ is defined as: $S_R(t) = A_R \sin(\omega t + \delta)$.

These two signals enter the PSD module for multiplication simultaneously, and the output of the PSD is defined as:

$$S_{psd} = S_I(t)S_R(t) = A_I A_R \sin(\omega t + \varphi) \sin(\omega t + \delta) + B(t)A_R \sin(\omega t + \delta)$$

$$= \frac{1}{2}A_I A_R \cos(\varphi - \delta) - \frac{1}{2}A_I A_R \cos(2\omega t + \varphi + \delta) + B(t)A_R \sin(\omega t + \delta)$$

In the time region, the output of the PSD consists three parts:

The first part is a DC signal. If A_I , A_R and the phase difference $(\varphi - \delta)$ between the input signal and the reference signal are constants, this part is a DC signal.

The second part is the frequency-doubled reference AC signal.

The third part is the result of multiplication of the noise and the reference. Because the sine signal is periodic and there is no relevance between the noise signal and the reference signal. The integral of this part is zero.

In the frequency region, we can redraw these three parts:

The first part is at 0Hz, which is known as the DC component of one signal.

The second part is at $2f_{ref}$ Hz.

The third part is a random signal at all the frequencies, such as white noise. The frequency spectrum of white noise does not change after any frequency drifts.

To sum up, the LPF output is defined as: $S_{Output} = \frac{1}{2}A_I A_R \cos(\varphi - \delta)$.

Although we can determine the amplitude of the input signal through adjusting the phase difference $(\varphi - \delta)$, the accuracy is unsteady and insecure. In order to solve this problem, the dual phase lock-in amplifier was invented, see Fig.3.

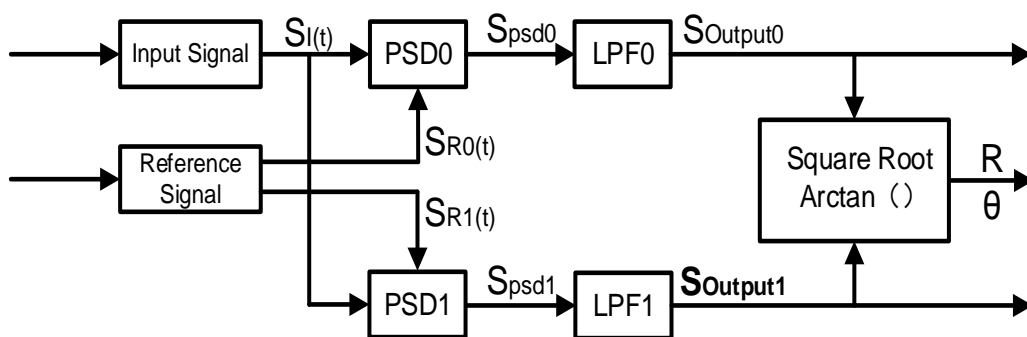

Fig.3 Dual Phase Lock-in Amplifier diagram.

Now, we define the phase difference $\theta = \varphi - \delta$, the LPF0 output $X = S_{Output0}$ and the LPF1 output $Y = S_{Output1}$. Then we calculate the amplitude R which is independent of θ :

$$R = \frac{A_I}{\sqrt{2}} = \frac{\sqrt{2(X^2 + Y^2)}}{A_R}$$

The phase difference is defined as: $\theta = \tan^{-1}(Y/X)$.

2.2 Functional Diagram

The functional block diagram of the OE1022 DSP Lock-In Amplifier is shown in Fig.4. On the whole, the OE1022 includes signal conditioners, reference signal generators, an algorithm module and a system control module and so on.

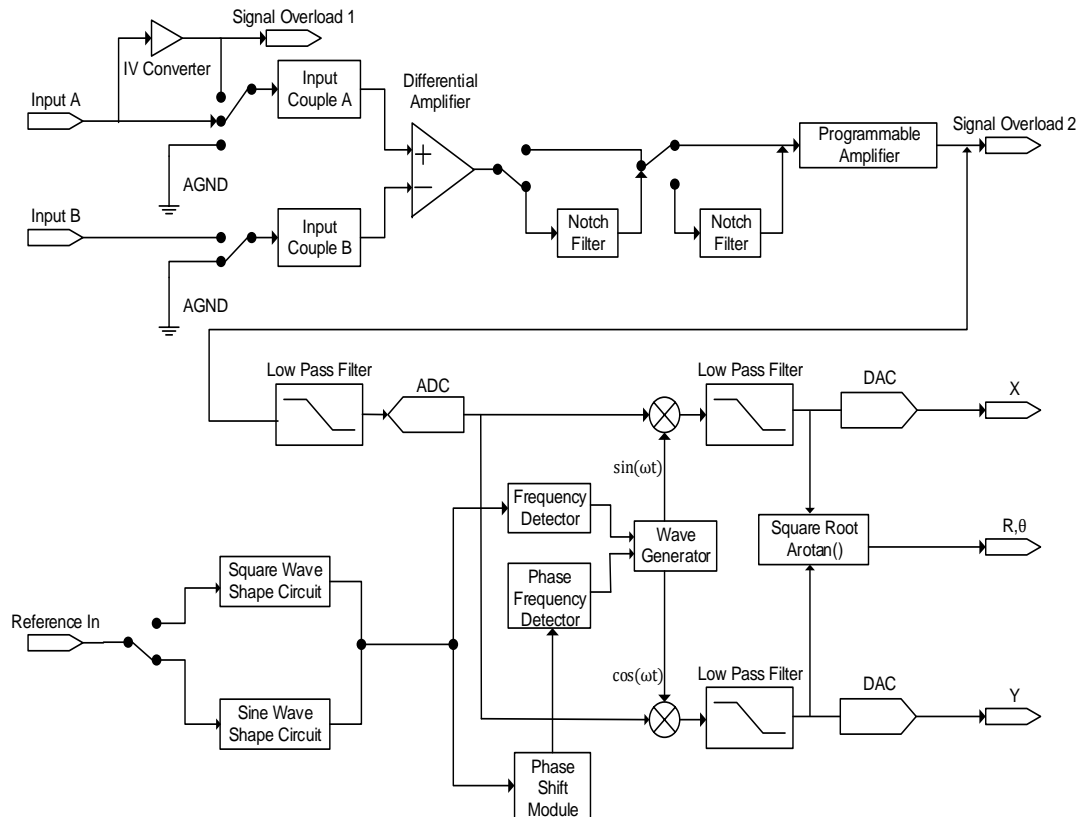

Fig.4 Functional Block Diagram of OE1022

2.3 Reference Channel

The reference channel is used to provide control signal which is associated with the detected signal. The OE1022 reference input can trigger on an analog signal such as a sine wave or a TTL logic signal. The input is AC coupled and the input impedance is $1M\Omega$.

Generally, both the sine wave and the TTL signal can be used as the reference signal. However, the generator's sine output has a small and varying amplitude. Meanwhile, many function generators provide a stable TTL SYNC output which can be used as the reference. Therefore, for frequencies below 1Hz, a TTL reference signal is required.

The OE1022 lock-in amplifier has two reference signal modes: internal reference mode and external reference mode.

In internal reference mode, the internal oscillator generates a digitally synthesized sine wave which is used to multiply with the input signal. The phase-locked-loop (PLL) is not used since the lock-in reference provides the excitation. The phase noise will not affect the internal reference signal. The phase noise is extremely low. This mode can work normally from 1mHz to 102kHz.

In external reference mode, an external sine wave or TTL logic signal can be used as the external reference signal. PLL will be used in this mode, but it will generate a little phase jitter which may cause measurement errors.

The phase jitter means that average phase shift is zero but the instantaneous phase shift has a few milli-degrees of noise. The phase jitter makes the reference signal plus noise at different frequencies. According to the coherence principle of PSD, the output is not a single frequency, but a distribution of frequencies about the true reference frequency.

In fact, phase noise in the OE1022 is very low and generally has no effect. In applications that requiring no phase jitter, the internal reference mode should be chose. Since there is no PLL in internal mode. The internal oscillator and the reference sine waves are directly linked and there is no jitter in the measured phase.

2.4 Phase Sensitive Detectors

The PSD in the OE1022 acts as a digital multiplier as is shown in Fig.5. The input signal amplified and filtered is converted to digital signal by a 24-bits A/D converter

and then goes into the PSD. The reference sine wave is computed to 24 bit of accuracy, and the accuracy of the whole PSD is 48 bit.

The PSD module in lock-in amplifier is mainly used to implement the coherent modulation of the input signal and reference signal. Generally, there are two kinds of phase-sensitive detectors (PSD's): digital PSD's and analog PSD's. Traditional PSD's use an analog multiplier to multiply the input signal with the reference signal. There are many problems associated with these, including harmonic rejection, output offsets, limited dynamic reserve and gain error. It will limit the accuracy of PSD's and bring in various noises.

The digital PSD multiplies the digitized signal with a digitally computed reference sine wave. Because the reference sine wave is computed to 24 bit of accuracy, the harmonics have -90 dB roll off. That is to say, the harmonics do not affect the products of the PSD.

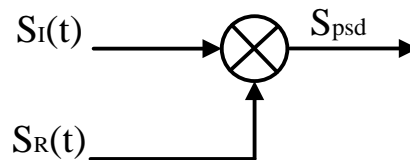

Fig.5 PSD diagram.

Because the PSD based on analog method has temperature drift, there are always some deviation between the output and actual result that is the uncertain system error. While the PSD based on digital method has a precise amplitude and never change, so it will not generate any system errors. This eliminates a major source of gain error in a linear analog lock-in. Considering that the inputs of analog multiplier are analog quantity, the reference signal will be affected by temperature drift. This will cause errors in the reference and greater errors in the results of coherent modulation.

The dynamic reserve of an analog PSD's is limited to about 60 dB, because there are always many background noises. When there is a large noise signal present, 1000 times or 60dB greater than the full-scale signal, the analog PSD measures the signal with an error. Because the lock-in amplifier is mainly used to detect weak signals, when the amplitude of background noise is similar to or larger than the signal amplitude, the results of coherent modulation will be wrong.

To the digital PSD's, the dynamic reserve is limited by the quality of the A/D conversion. Once the input signal is digitized, no further errors are introduced. Practically, the dynamic reserve of OE1022 can exceed 100dB.

The performance of a lock-in amplifier is largely determined by the performance of its PSD's. Almost in all respects, the digital PSD outperforms the analog one. Besides, the digital PSD is also more convenient to modify.

2.5 Time Constants and DC Gain

The output signal of the PSD contains many signals of various frequency, such as the sum or difference between the input signal frequency and the reference frequency. Only the signal whose frequency is exactly equal to the reference frequency will result in a DC output.

The low pass filter (LPF) at the PSD output removes all the AC signals that unwanted, including the 2F (sum of the signal and the reference) and the noise signals. This filter is what makes the lock-in such a narrow band detector.

Time Constants

The bandwidth setting of the low pass filter is the same as the conventional low pass filter. They are both determined by the time constants. The calculation of the time constant is defined as:

$$TC = \frac{1}{2\pi f}$$

Here f is the -3dB frequency of the low-pass filter. For example, to a one-order low pass filter of RC type, a 1s time constant means its -3dB point occurs at 0.16Hz.

In fact, where there is an input noise, there is an output noise. By increasing the time constant, the output becomes more stable and measurement becomes more reliable. The time constant reflects not only the stability of the system and the accuracy, but also the respond time of the output.

The time constant also determines the equivalent noise bandwidth (ENBW). The ENBW isn't the filter -3dB pole, it is the effective bandwidth for Gaussian noise.

Digital Filters vs Analog Filters

Analog filters have many limitations in performance. The temperature drift and non-linearity are two important problems that limit the rolloff performance of an analog filter. A two-stage analog filter provides about a maximum rolloff of 12 dB/oct at high frequency points.

Space and expense are also limitations. Each filter needs to have many different time constant settings. These different settings require different components and switches to select. Each setting is costly and space consuming. A large quantity of analog devices also bring quite complexity to the device debugging.

Considering these limitations, we choose a 47 bits digital filter to accomplish narrow band filtering. The DC amplitude is exactly 0 dB and the equivalent value of Q exceeds 145dB.

Synchronous Filters

Another advantage of digital filtering is to do synchronous filtering. Even if the input signal has no noise, the PSD output always contains a component at $2F$ (sum frequency of the signal and the reference) whose amplitude may exceed the difference frequency component that we want. At low frequencies, increasing the time constant can attenuate the $2F$ component.

In OE1022, synchronous filters are available at detection frequencies below 200 Hz. At higher frequencies, the filters are not required because the $2F$ component is easily removed without using long time constants. The output of the synchronous filter is followed by two more stages of normal filters. This combination of filters can eliminate the harmonics of the reference signal and attenuate other noise signals.

Long Time Constants

Time constants above 100s are difficult to accomplish by using analog filters. This is simply because the capacitors required for the RC filters are prohibitively large in value and size. Why would you use such a long time constant? Sometimes you have no choice. If the reference is below 1 Hz with a lot of noise at low frequency, the PSD output will contain many low frequency components. Nevertheless, the synchronous filter only filters out the harmonic component of the reference frequency, and the followed filters filter the noise.

The OE1022 provides time constants as long as 3000s when the reference frequency is below 200 Hz, which can satisfy most requirements of measurements.

DC Output Gain

How big is the DC output from the PSD? It depends on the dynamic reserve. With a 60 dB dynamic reserve, a noise signal can be 1000 times (60 dB) greater than a full scale signal. At the PSD, the noise cannot exceed the input range of PSD. For example, in an analog lock-in, the PSD input range might be 5 V. With 60 dB dynamic reserves, the signal will be only 5 mV at the PSD input. The PSD typically has no gain so the DC output from the PSD will only be a few millivolts. Even if the PSD had no DC output errors, amplifying this millivolt signal up to 10 V is error prone. An offset as small as 1 mV will appear as 1 V at the output. This is one of the reasons why analog lock-in does not perform well at high dynamic reserve.

The digital lock-in does not have an analog DC amplifier, and has no DC output offset. Likewise, the digital DC amplifier has no input offset. The output of the digital DC amplifier is simply the product of the input signal and the required gain.

This allows the OE1022 to operate with 100 dB of dynamic reserve without any output offset or zero drift.

2.6 DC Outputs and Scaling

The OE1022 has Channel 1 and Channel 2 outputs (CH1 and CH2) on the front panel.

CH1 and CH2 Outputs and Display

The output range of CH1 and CH2 is from -10V to 10V.

The output signal is proportional to the value of the test signal and the setting scale. Otherwise, the OE1022 shows the values of CH1 and CH2 on the front panel, including the value of X, Y, R, θ of the test signal. The display interface of OE1022 is shown in Fig.6.

OE1022 can display the value of CH1 and CH2 through bars in addition to numbers. To discover the changes of data, you can observe the data in the time region.

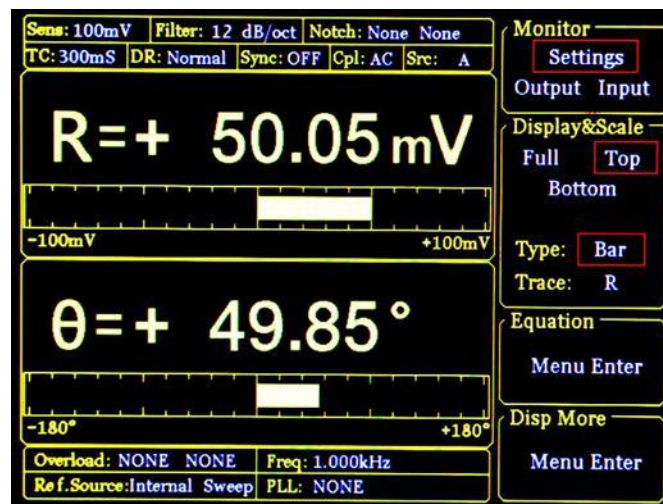

Fig.6 Display Interface of OE1022

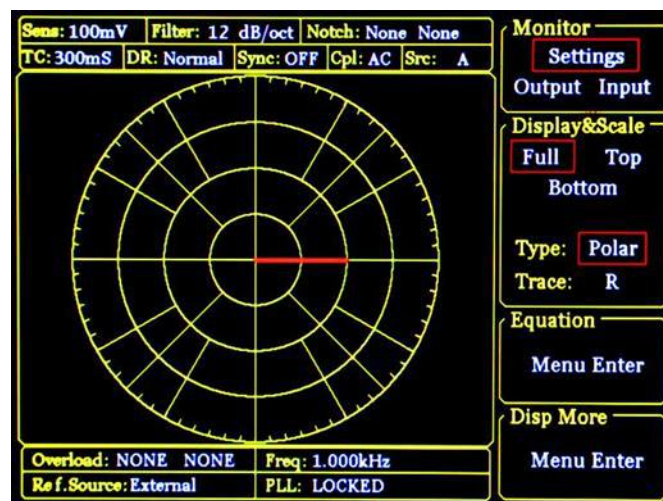

Fig.7 Polar Display Mode

Otherwise, OE1022 can use polar coordinates to display the vector combined with the co-phase and quadrature component of test signal. The polar display interface is shown in Fig.7. All display modes can simply adjust the display ratio by hand operation. The auto-adjust function can optimize the display mode rapidly.

X, Y and R Output Offset and Expand

The OE1022 has the ability to offset the X, Y and R outputs, which is useful when measuring deviations in the signal around some nominal value. The output can be offset to zero by setting the offset. Then changes in the output can be read directly from the display or output voltages. The offset is specified as a percentage of full scale. Offsets can be set up to 100% of full scale. When the sensitivity is changed, the percentage does not change.

The X, Y and R outputs can be expanded. It's realized by multiplying the output with an expansion factor. Thus, a signal which is only 10% of full scale can be expanded to provide 10 V rather than 1 V. The general use for expansion is to increase the measurement resolution around some value which is not zero.

When the output does not exceed the full scale, the OE1022 can expand the output by multiplying with the expansion factor from 1 to 256. The output with offset and expand is:

$$\text{Output} = \left(\frac{\text{Signal}}{\text{Sens}} + \text{Offset} \right) \times \text{Expand} \times 10(\text{V})$$

Where <Offset> can be set up to $\pm 100\%$ by the digital keyboard and the minimal step is 0.01%. <Expand> can be set from +1 to +256 by the digital keyboard and the minimal step is 1. Related display interface is shown in Fig.8.

For example, there is:

$$\text{Output} = \left(\frac{0.1\text{mV}}{1\text{mV}} + 0.2 \right) \times 2 \times 10(\text{V}) = 6(\text{V})$$

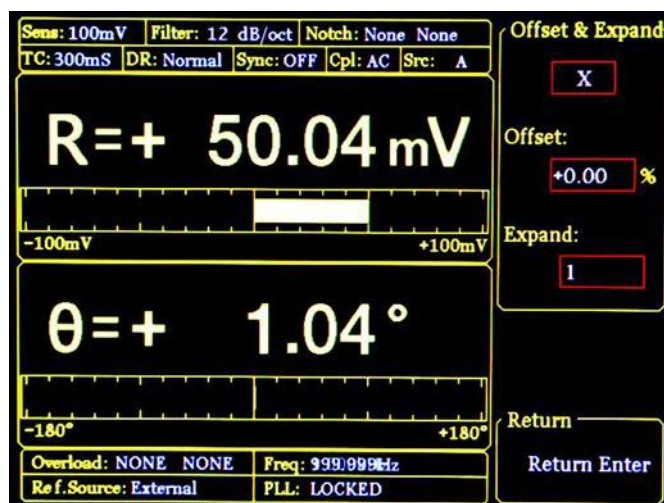

Fig.8 Output Offset and Expand

2.7 Dynamic Reserve

The definition of dynamic reserve is the ratio of the largest tolerable noise signal to the full scale signal, expressed in dB, which is defined as:

$$\text{Dynamic reserve} = 20(\text{OVL}/\text{FS})(\text{dB})$$

Here OVL is the total dynamic range of the input signal. FS is the dynamic range of the output signal. If the dynamic reserve is 100 dB, the tolerable noise can be 10^5 times the input.

The 'tolerable' means that the noise at the dynamic reserve limit should not cause an overload anywhere in the instrument. Overload might appear at the input of the pre-amplifier and the output of DC amplifier. We can adjust the distribution of the gain to achieve high dynamic reserve. This means that the input signal gain at the pre-amplifier should be set very low so the noise is not likely to overload. Then the low pass filter removes the large noise component from the PSD output which allows the remaining DC components to be amplified to reach 10 V full scale.

This gain is distributed between AC gain before the PSD and DC gain following the PSD. The total gain is the product of the AC gain and the DC gain. Suppose the total gain is a constant. If the AC gain increases and the DC gain decreases, the input noise is easy to overload after AC gain. Thus, the dynamic reserve and the DC drifts decrease. In contrast, if the AC gain decreases and the DC gain increases, the dynamic reserve increases. In this case, the output stability will decrease and the accuracy of measurement will be lower.

The noise frequencies and amplitudes affect the accuracy of the DC output signal. Noise at the reference frequency with large amplitude becomes part of the DC signal after the PSD. This enlarges the output error of the lock-in amplifier.

The dynamic reserve is related to noise frequency. The dynamic reserve is 0dB at reference frequency and increases when the noise frequency moves away from the reference frequency. It reaches a maximum value when the frequency is far enough. The dynamic reserve near the reference frequency is important to noise tolerance of the instrument. Providing more low pass filter stages can improve the performance of the filters and then increase the dynamic reserve close to the reference frequency. The dynamic reserve far from the reference frequency is generally high but has little influence.

The dynamic reserve of OE1022 is greater than 100dB. High dynamic reserve will increase output noise and drift. When the dynamic reserve is high, output noise will be increased due to the A/D converter. There is background noise at any signal. When the signal is amplified by PSD, the output signal will contain noises. If the noise is very high, it will result in large output noise. Otherwise, if the external noise is very low, the output is mainly affected by the noise of OE1022. Reducing

dynamic reserve and DC gain can decrease the error. Therefore, low dynamic reserve should be chosen firstly in actual application.

In fact, the minimum reserve changes with the sensitivity (gain) of the instrument. At high gains, the minimum dynamic reserve increases with the increase of the sensitivity. In analog lock-in amplifiers, low dynamic reserve means low output error and drift. In OE1022, high dynamic reserve increases output noise, but not increases output error and drift. However, if the gain of analog amplifier is high enough, the amplified intrinsic noise will be greater than the noise generated by the A/D converter. In this case, increasing the analog gain cannot decrease the output noise. At high sensitivity, decreasing the gain will increase the dynamic reserve.

2.8 Signal Input Amplifier and Filters

A lock-in amplifier can measure signals as small as a few nanovolts. The gain of the low noise signal amplifier should be large enough so that the output signal can be digitized by the A/D converter without degrading the signal to noise ratio (SNR). The analog gain of the OE1022 ranges from roughly 7 to 1000 times. Higher gains do not improve the SNR.

The overall gain (AC plus DC) is determined by the sensitivity and the distribution of the gain is set by the dynamic reserve.

Input Noise

In OE1022, the input noise is about $10 \text{ nV}_{\text{rms}}/\sqrt{\text{Hz}}$. If an amplifier has $10 \text{ nV}_{\text{rms}}/\sqrt{\text{Hz}}$ of input noise and a gain of 1000, the output will have $10 \text{ } \mu\text{V}_{\text{rms}}/\sqrt{\text{Hz}}$ of noise. Suppose the output of the amplifier is low-pass filtered by a single RC filter (6 dB/oct rolloff) with 100ms time constant.

Input noise of lock-in amplifier and Johnson noise of resistors are both Gaussian in nature. That is to say, the amplitude of noise is proportional to the square root of the noise bandwidth. A single-stage RC filter has an ENBW of $1/4T$ where T is the time constant (RxC) which means that Gaussian noise is filtered with an effective bandwidth equal to ENBW. In this case, the filter sees $10 \text{ } \mu\text{V}_{\text{rms}}/\sqrt{\text{Hz}}$ of input noise and has an ENBW of $1/(4 \times 100\text{ms})$ or 2.5 Hz. The voltage noise at the filter output will be $10 \text{ } \mu\text{V}_{\text{rms}}/\sqrt{\text{Hz}} \times \sqrt{2.5\text{Hz}}$ or $15.8 \text{ } \mu\text{V}_{\text{rms}}$.

For Gaussian noise, the peak-peak noise is about 5 times the rms noise. Thus, the output noise will be about $79 \text{ } \mu\text{V}_{\text{rms}}$. Input noise works in the same way. For sensitivities below $5 \text{ } \mu\text{V}$, the value of input noise determines the output noise.

ENBW depends on the time constant and filter roll off. For example, suppose the OE1022 is set to $\langle 5 \text{ } \mu\text{V} \rangle$ full scale, $\langle 100 \text{ ms} \rangle$ time constant and $\langle 6\text{dB/oct} \rangle$ roll off. Thus, ENBW is 2.5 Hz. This leads to $7.9 \text{ nV}_{\text{rms}}$ input noise. At the output, this causes about 0.16% of full scale ($7.9 \text{ nV}/5 \text{ } \mu\text{V}$). The peak to peak noise will be about 0.8% of full scale.

Assume that the signal input is from a low impedance source. The Johnson noise of resistors equals to $0.13 \times \sqrt{R}$. Take a 100Ω resistor for example, its noise is almost $1.3 \text{ nV}_{\text{rms}}/\sqrt{\text{Hz}}$. When the impedance of the resistor is $2 \text{ k}\Omega$, the Johnson noise is greater than the input noise of OE1022. The overall noise of multiple noise sources is determined by the square root of the sum of the squares of the individual noise figures. For example, if a $1 \text{ k}\Omega$ source impedance is used, the Johnson noise will be $4.11 \text{ nV}_{\text{rms}}/\sqrt{\text{Hz}}$.

At low gains (sensitivities above $50 \text{ } \mu\text{V}$), the gain is not high enough to amplify the

input noise to a level greater than the noise of the A/D converter. In these cases, the output noise is mainly the A/D noise. At these sensitivities, the DC gain is low and the noise at the output is negligible.

Notch Filters

There are two notch filters in the signal amplifier chain in OE1022. They are pre-tuned to the line frequency and twice the line frequency. When the largest noise signals are at the power line frequencies, these filters can remove noise signals at these frequencies. Removing the largest noise before the final gain stage will reduce the dynamic reserve required to perform a measurement.

To prevent such a situation, it is necessary to improve the signal amplifier chain. If the required dynamic reserve without these notch filters is below 60 dB or if the minimum reserve is sufficient, then these filters do not improve the measurement obviously.

Do not use notch filters when making measurement near the notch frequencies. Notch filters have a finite range of attenuation, generally about 10 Hz. Thus, if the lock-in is measuring at 90Hz, do not use the 80 Hz notch filter. Otherwise, the signal will be attenuated and the measurement will be wrong. Besides, notch filters also have effect on phase shifts measurements.

Anti-aliasing filter

After signal filtering and amplification, there is an anti-aliasing filter, which is required by the signal digitization process. According to the Nyquist criterion, the sampling frequency of signal must be at least twice the highest signal frequency. For example, the highest signal frequency is 100 kHz, then the sampling frequency is 312.5 kHz. However, signals above 156 kHz cannot reach the A/D converter. These signals would violate the Nyquist criterion and be under-sampled. The result of under-sampling is to make the higher frequency signals appear as lower frequency signal in the digital data stream. This would make the measurement wrong.

To avoid under-sampling, the analog signal is filtered to remove signals above 154 kHz. This filter has a flat pass bandwidth from DC to 102 kHz so that it would not affect measurements in the operation range of the lock-in. The filter rolls off from 102 kHz to 154 kHz and achieves an attenuation of at least 100dB above 154 kHz.

Input Impedance

The input impedance of OE1022 is 10 M Ω . If a higher input impedance is desired, the OE1022 remote preamplifier must be used so that the OE1022 has the maximum input impedance of 100 M Ω .

2.9 Input Connections

Noises always exist in all circuits. Even if the signal is not very weak, noises exist and decrease the accuracy of measurement. There are many methods to reduce noise. Minimizing the various noise sources can increase the accuracy of the measurement. Besides, the effect of noise sources in the laboratory and the problem of the differential grounds between the detector and the lock-in can be minimized by careful input connection.

There are two basic methods for input connection - the single-ended connection is more convenient while the differential connection eliminates spurious pick-up more effectively.

Single-Ended Connection (A)

In the first method, the lock-in uses the A input in a single-ended mode. The lock-in detects the signal as the voltage between the center and outer conductors of the A input only. However, there are two disadvantages of this mode.

Generally, the low level is a constant of 0V. However, grounds of different instruments may be at different potentials. When the shield of the A cable is connected to the lock-in's ground directly, different potentials will result in a high current, that is the ground loop. Thus, connecting via a resistor between them can avoid ground loop problems. In general, float uses 10 k Ω and ground uses 10 Ω .

Besides, this mode is not sensitive to noise. The signal cable is just like an antenna. The lock-in lets the shield 'quasi-float' in order to sense the experiment ground and pick up the activities of the electronic in environment. In this case, the noise came up. Unfortunately, the single-ended connection mode cannot distinguish the noise and actual signal.

Differential Connection (A-B)

The second method of connection is the differential mode. This mode has two signals cables which connect the signal source and the lock-in's inputs. There are two high impedance power amplifiers in the lock-in. The lock-in measures the voltage difference between the center conductors of the A and B inputs, which can avoid common voltage problems since the shields are ignored.

In this mode, take care that the two cables travel the same path between the experiment and the lock-in. There should not be a large loop area enclosed by the two cables. Otherwise, measurement is susceptible to magnetic pickup.

2.10 Intrinsic Noise Sources

Noise is defined as any negative factors which will affect the result of measurement. Noise is random, unpredictable and temporary. Good experimental design should reduce the noise and improve the stability and accuracy of measurement.

There are various intrinsic noise sources which are present in all electronic signals. Some of them are unavoidable which only can be decreased by signal averaging and a narrower bandwidth. Others can be decreased by filtering and perfect line structures and component layout. Meanwhile, amplifier itself also produces noise at work, which can be solved by low noise amplifier design techniques.

Johnson Noise

Every resistor generates a noise voltage across its terminals due to thermal fluctuations in the electron density within the resistor itself. This is Johnson noise. The spectrum of the Johnson noise is flat, so the noise power is almost the same in different frequency band (Of course there is an upper limit frequency). In this case, the noise is called white noise. The fluctuations give rise to an open-circuit noise voltage,

$$V = (4kTRB)^{1/2}$$

Where $k=1.38 \times 10^{-23} \text{ J/}^\circ\text{K}$ is the Boltzmann's constant. T is the temperature in $^\circ\text{Kelvin}$, which can be transformed to $^\circ\text{Celsius}$: $^\circ\text{K} = ^\circ\text{C} + 273.16$. R is the resistance in Ohms, and B is the bandwidth of the measurement in Hz.

Harry Nyquist's mathematical studies of Johnson noise revealed that the power spectrum function of Johnson noise is:

$$St(f) = 4kTR(V^2/\text{Hz})$$

At 300 $^\circ\text{K}$, a resistor of 10 $\text{K}\Omega$ is connected to the input of the amplifier. The voltmeter is connected to the output of the amplifier. The open-circuit effective voltage of the filter which has a 10 kHz bandwidth is 1.3 μV .

The amplitude of Johnson noise is unpredictable in normal cases. It follows the Gaussian distribution. Johnson noise is the minimum value of the noise voltage of any devices including detectors, signal sources and amplifiers with resistors. Johnson noise is a typical case of wave dissipation.

Shot Noise

Because of the finite nature of the charge carriers, electric current has noise. Noise generates in the current since there is always some non-uniformity in the electron flow. This noise is called shot noise. It appears as voltage noise when current is passed through a resistor, or as noise in a current measurement.

If the effect between carriers is ignored, the shot noise or current noise is given by:

$$I = (2qI_{dc}B)^{1/2}$$

where q is the electron charge of 1.6×10^{-19} Coulomb, I_{dc} is the DC current and B is the bandwidth. If I_{dc} is 1 A DC current and B is 10 kHz, then, I is 57 nA which is about 0.000006% of I_{dc} . At a smaller current, the fluctuation is larger. For example, if I_{dc} is 1 μ A and B is still 10 kHz, then, I is about 0.006% or -85 dB. If I_{dc} is 1 pA, then, I is about 5.6% or 56 fA.

In fact, shot noise is one kind of the white noise. Its power spectrum density is given by:

$$S_{si}(f) = 2qI_{dc} \text{ (A}^2/\text{Hz)}$$

The formula is based on the assumption that carriers in the current do not affect each other. This assumption exists, such as the diffusion current in the junction diode. However, for general metal, this formula cannot be used because the cross effect between carries cannot be ignored.

Flicker Noise (1/f Noise)

In 1925, Johnson first found 1/f noise in in tube currents. The power spectrum function of this noise is proportional to 1/f. The lower the frequency, the more serious the noise. Thus, it is also called low frequency noise. Microscopically, 1/f noise is caused by the random value of contact resistance between two conductors. The current amplitude of 1/f noise follows the Gaussian distribution, and the power spectrum density is proportional to 1/f which is given by:

$$S(f) = \frac{KI_d^2}{f} \text{ (V}^2/\text{Hz)}$$

1/f noise is also called flicker noise due to the random fluctuation of the power spectrum density in active devices. It broadens the bandwidth near the center frequency and reduces the value of Q of oscillators. 1/f noise must be considered near the center frequency.

Total Noise

Johnson noise and shot noise are unreducible. Any resistors with a same resistance have the same Johnson noise. Shot noise relies on the special manufacture of resistors, including its material and package technology and so on. For example, among winding resistor, metal film, carbon resistor and pure carbon, the winding resistor has the minimum resistance. The metal film resistor and carbon resistor have larger resistances. The pure carbon resistor has the maximum resistance of these four. All of these noises are incoherent. The total random noise is the square root of the sum of the squares of all the incoherent

noise sources.

2.11 External Noise Sources

In addition to the intrinsic noise sources discussed previously, there are different kinds of external noise sources. Most of these noise sources are asynchronous and not related to the reference. They do not occur at the reference frequency or its harmonics. These noise sources affect the measurement mainly by increasing the requirement of dynamic reserve or lengthening the time constant. However, some external noise sources are related to the reference. If they are picked up in the signal, noise will add or subtract from the actual signal and cause errors in the measurement. Fortunately, external noise sources can be reduced through various ways.

Capacitive Coupling

The mutual capacity between wires is often called stray capacity C_{stray} . An AC voltage from a nearby piece of apparatus can couple to a detector via C_{stray} . Although C_{stray} may be very small, the coupled noise may still be larger than a weak experimental signal and cause severe instability for the detector. The noise current is given by:

$$I = \omega C_{\text{stray}} V_{\text{noise}}$$

where ω is 2π times the noise frequency, V_{noise} is the amplitude of noise, and C_{stray} is the stray capacitance.

When the noise sources' frequency become larger, the coupling noise will be larger. If the noise source is at the reference frequency, the noise will be quite large. The lock-in rejects noise at other frequencies, but pick-up at the reference frequency appears as signal.

Cures for capacitive noise coupling include:

- 1) Remove or turn off the noise source.
- 2) Design the experiment to measure voltages with low impedance for most of low frequency noise sources.
- 3) Install capacitive shielding by placing the experiment and detector in one metal box.

Inductive Coupling

An AC current in a nearby piece of apparatus can couple to the experiment via a magnetic field. A changing AC current gives rise to a changing magnetic field which induces voltage. The larger the frequency, the larger the electromotive force, the greater the measurement error.

Cures for inductively coupled noise include:

- 1) Remove or turn off the interfering noise source.
- 2) Reduce the area of the pick-up loop by using twisted pairs or coaxial cables.
- 3) Use magnetic shielding to prevent magnetic field from crossing the area of measurement.

Resistive Coupling or Ground Loops

The ground loop is an interference source which can generate noise voltage between the grounds. If the noise voltage is large enough, it will cause measurement errors. Ground loop is a physic loop, which generates from many ground methods. These grounding methods can act as a big loop wire. They pick up noises from the environment and generate voltages in the grounding system. The 50 Hz magnetic field of the AC power is a normal noise source that the ground loop always pickup. For distributed grounding systems, the ground voltage can cause the ground current flow in the ground loop. Since the ground is with low impedance, noise current is always very high.

Cures for ground loop problems include:

- 1) Connect all grounds to the same physical point.
- 2) Use a heavy ground bus to reduce the resistance of ground connections.
- 3) Remove sources of large ground currents from the ground bus.

Microphonics

Not all noise sources are electrical in origin. According to microphonic effects, mechanical noise can be transformed into electrical noise. Physical changes in the device or cables (due to vibrations for example) will cause electrical noise over the whole bandwidth of the lock-in.

Solutions to minimize microphonic signals:

- 1) Eliminate mechanical vibrations near the experiment.
- 2) Tie down cables carrying sensitive signals.
- 3) Use a low noise cable that is designed to reduce microphonic effects.

Thermocouple effects

When two dissimilar metals contact, there will be potential difference between them. The reason for potential difference includes: (1) different electronic work function of two metals. (2) different electron concentration of two metals.

Suppose that metal A and metal B have work functions V_a and V_b respectively. The electromotive force (emf) between A and B is:

$$V_{ab} = V_a - V_b + \frac{kT}{q} \times \ln\left(\frac{N_a}{N_b}\right)$$

Where $k = 1.38 \times 10^{-23} \text{ J/K}$ is Boltzmann's constant. T is the temperature in °Kelvin; q is the elementary charge of 1.60×10^{-19} Coulomb. It's found that from the formula, the contact potential depends on the nature of the metal and the temperature of the contact surface.

If two dissimilar metals contact, the electromotive force at the contact point will plus a slowly changing millivolt level. This kind of noise is sensitive to temperature. This noise is typically at very low frequency because the temperature of the detector and experiment generally changes slowly. This effect is large on the scale of many detector outputs and can be a problem for low frequency measurements, especially in the mHz range.

Solutions to minimize thermocouple effects:

- 1) Hold the temperature of the detector or experiment constant.
- 2) Use a compensation junction.

2.12 Aux In/Out

There are four 16-bit high-precision AUX-ADC input channels in OE1022. The input voltage ranges from - 10 V to + 10 V and the minimum resolution is 0.3 mV. These 4 ADC channels can clamp the input signal and amplify the internal differential signal. The input impedance is 1 MΩ. At the same time, they can pick up signals to measure slow analog signals or DC signals (the signals come from temperature sensor and pressure sensor). This is useful for proportional operation and transferring data to computer.

Because of the internal special structure of the 4 AUX-ADC channels, the measurement result is about 2.048V when the input is floating.

There are also four 16-bit high-precision AUX-ADC output channels in OE1022. The output voltage ranges from - 10 V to + 10 V and the minimum resolution is 0.3 mV.

The AUX IN and AUX OUT ports use standard BNC connectors on the rear panel. The setting for AUX ADC/DAC can be made in the [display] / [AUX OUTPUT] sub-menu.

2.13 Sweep Frequency and Amplitude of Signal Generator

The OE1022 adds some new functions, such as frequency and amplitude scanning. Signal generator can scan the output amplitude and frequency. Uses can sweep the frequency they interested in and analyze the characteristics of the

signal. This function greatly increased the actual application

The basic way of frequency and amplitude scanning is setting the value of the start and end point, and increasing the value by step and then the scan is over. See more details in the sections related to frequency and amplitude scanning.

2.14 FFT Spectral Analysis

FFT is Fast Fourier transformation. It is an algorithm that extracts the frequency domain information of the signal. Generally, it is hard to analyze the signal's features in time domain. But it is easy to analyze the component of the signal at each frequency if the signal is in frequency domain. This is beneficial to evaluate the signals in all aspects.

FFT comes from the improvement of DFT. To DFT, the result is proportional to the square of N. If N is large, like 1024, 1048576 operations are required. Therefore, it is impossible to analyze spectrum and process the signal in real time by using DFT.

The FFT algorithm rapidly computes such transformations by factorizing the DFT matrix into a product of sparse factors and reduce the complexity of the computing the DFT by using periodicity and symmetry. For example, divide the N-sequence into two N/2-sequence. $(N/2)^2$ times' calculations are needed for every N/2 point DFT. Then every two N/2 point DFT can combine into one N point DFT after N times' operations. After this transformation, the total operation times will be $N+2*(N/2)^2=N+N^2/2$. Thus, when $N=1024$, the total operation times are 525312, which save about 50% of the computation.

OE1022 develops and integrates the function of FFT high accuracy spectrum analysis, which can realize the frequency domain analysis from 1 kHz to 102 kHz and display the spectrum distribution of the signal in real time. The setting of FFT is in the menu of [DISPLAY].

2.15 Multi-harmonic Detection

Harmonics represent waves at multiple frequencies. Periodic function can be described as the linear combination of one constant and many sine or cosine functions with the base frequency and the multiple frequencies. The constant is the DC component. The base frequency component is the base wave. The multiple frequencies are harmonics.

Now many lock-in amplifiers can only measure one base wave or one component of harmonics at one time. But in most practical applications, it is necessary to measure and record multiple harmonics simultaneously. In order to solve this problem, OE1022 realized multi-harmonic detection. Up to 3-channel harmonic

components can be measured by one OE1022 at the same time.

3. INTERFACES

3.1 Front Panel

The front panel of OE1022 is shown in Fig.9.



Fig.9 Front Panel of OE1022

- Display** The OE1022 uses a 5.6-inch TFT-LCD for display and interactive control. Display resolution is 640*480. 8 levels of background brightness are available, which is set in the [SYSTEM] sub-menu. The measurement results are displayed at the left of the screen. It can provide single or double area for display. Otherwise, each area can display number, XY coordinates and polar coordinates. The right of the screen is used to choose and modify control conditions of measurement.
- Soft Keys** There are 5 soft keys on the right side of the display screen. The soft keys' functions change with the current menu. In general, these soft keys have two main functions, one is to choose different setting options, and another is to highlight some parameters and then use the knob or keyboard to input. For all functions, soft key only work with parameters that are adjacent to it.
- Spin Knob** The knob is used to adjust parameters which are highlighted. Most parameters can be adjusted by the spin knob.
- Keyboard** The keyboard consists of 3 groups of buttons. The [ENTRY] area is used to input the highlighted parameters by data forms. The [MENU] area is used to change the parameter list at the right side of the screen. And it provides 10 different function menus. The [CONTROL] area provides ancillary functions for measurement, like [CURSOR].
- BNC Connectors**
- REF IN The reference input can be a sine wave or a TTL pulse. When input

is a sine wave, the input impedance is $1\text{M}\Omega$ AC coupled. For low frequencies ($<1\text{Hz}$), it is necessary to use a TTL reference signal.

- SINE OUT** The signal generator can provide programmable voltage which is up to 5 V. The output impedance is $50\ \Omega$. If using the external reference signal, the signal generator can lock the phase of the input signal through PLL.
- CH1&CH2** The output range of CH1&CH2 OUTPUT is from -10 V to +10 V. According to ratio of the measurement result and setting measurement range, the input is proportional to output.
- SIGNAL IN** There are two signal input modes, single-ended A and differential, A-B. The input A can be current signal. When measuring voltage, the input impedance of A and B are both $10\ \text{M}\Omega//25\text{pF}$. When measuring current, the input is connected to the ground via a $1\text{k}\Omega$ resistor.

3.2 Rear Panel

The rear panel of OE1022 is shown in Fig.10. It includes a cooling fan, a power connector, a power switch, an USB interface and extended functional interfaces. The extended functional interfaces include AUX IN, AUX OUT, TRIG IN, TTL OUT, and MONITOR.



Fig.10 Rear Panel of OE1022

- Power Connector** The power connector is used to provide power for the instrument. This power connector with a build-in fuse receives 220 V, 50 Hz AC power. And it can filter high frequency noise.
- USB** The OE1022 lock-in amplifier communicates with the PC through a USB interface so that the PC can control the OE1022 and read data directly from it.
- AUX IN** AUX_ADC input 1-4(A/D Inputs). These are auxiliary analog inputs

which can be digitized. The range is -10V to +10V.

AUX OUT	AUX_DAC output 1-4(D/A Outputs). These are auxiliary analog outputs. The range is -10V to +10V.
TRIG IN	TRIG IN receives a TTL input used to trigger data samples and to start data acquisition. The rise edge is effective for TRIG IN. The maximum sample rate is 500 Hz.
TTL OUT	The TTL output is synchronous with [SINE OUT]. When the amplitude of [SINE OUT] is so small, [TTL OUT] can be used to make a sync phase lock.
MONITOR	Monitor provides an output from the signal amplifiers and filters. This is the signal just before the A/D converter and PSD. However, because the analog gain will not be too high, very small signals may not be amplified enough to viewed at the monitor output.

3.3 Main Display

The main display is divided into 4 parts, including status bars, data bar, monitoring bar and function bar.

3.3.1 Status Bars

As is shown in Fig.11 and Fig.12, the status bars indicate the current settings of the system or the results of measurement. Users can switch what to display in the submenu [DISPLAY].

Status bars can show the following parameters:

<Sens>	The value of sensitivity
<Filter>	The value of the filter roll-off.
<Notch>	The status of notch filter.
<TC>	The value of time constant.
<DR>	The status of dynamic reserve.
<Sync>	The status of synchronous filter.
<Cpl>	The couple mode.
<Src>	The input mode.
<X>	The X value of input signal.
<Y>	The Y value of input signal.
<R>	The R value of input signal.
<θ>	The θ value of input signal.

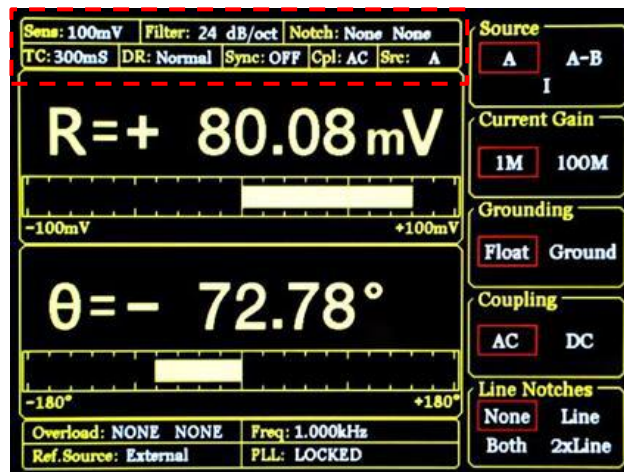

Fig.11 Main Interface: Status Bar 1

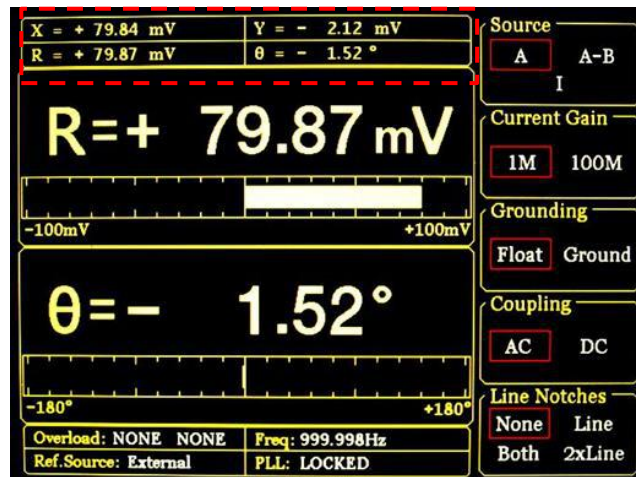

Fig.12 Main Interface: Status Bar 2

3.3.2 Data Bar

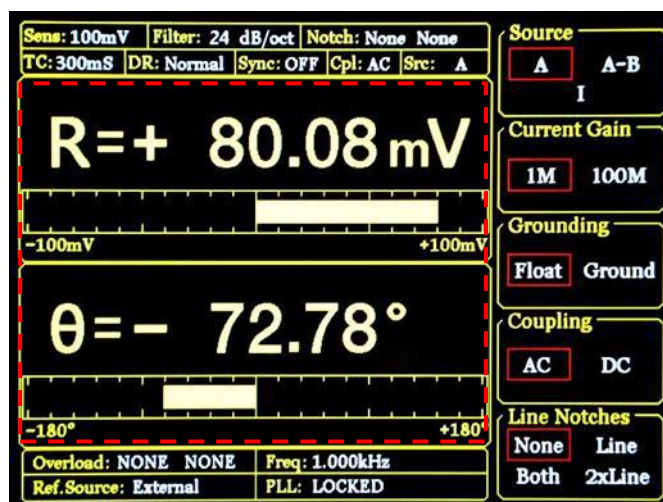

Fig.13 Main Interface: Data Bar

Users can choose which to display among <X>, <Y>, <R>, <theta> in [DISPLAY] submenu,

as is shown in Fig.13. How to display is also optional, such as number chart, bar chart, XY coordinate graph and pole coordinate graph. More details about setting is in [DISPLAY] submenu.

3.3.3 Monitoring Bar

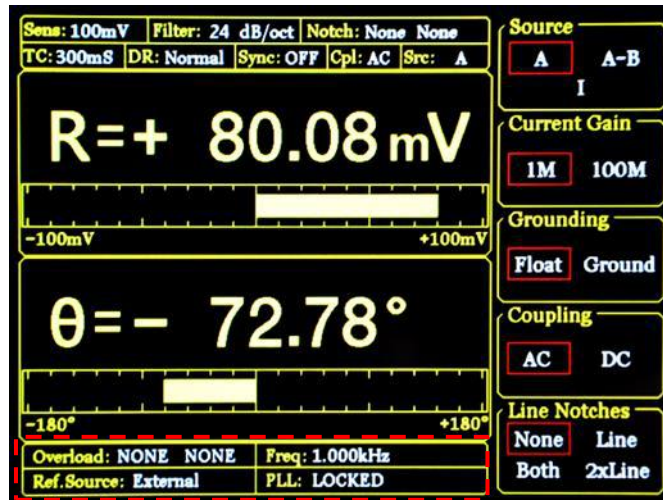

Fig.14 Main Interface: Monitoring Bar

The monitoring bar is at the bottom of the screen as is shown in Fig.14:

<Overload>

To indicate an input overload or amplification overload.

If there is no overload, it shows <Overload: NONE NONE>;

If an input overload, it shows <Overload: INPUT NONE>;

If an amplification overload, it shows <Overload: NONE GAIN>;

If there are both an input overload and amplification overload, it shows <Overload: INPUT GAIN>. In this case, reduce the input as soon as possible to prevent over-voltage damage to the instrument.

<Freq>

Display the frequency of input signal.

<Ref. Source>

The mode of the reference signal: Internal or External.

<PLL>

The status of PLL.

If the internal reference is used, it shows <PLL: UNLOCK>.

If the external reference is used, it shows <PLL: LOCKED>.

3.3.4 Function Bar

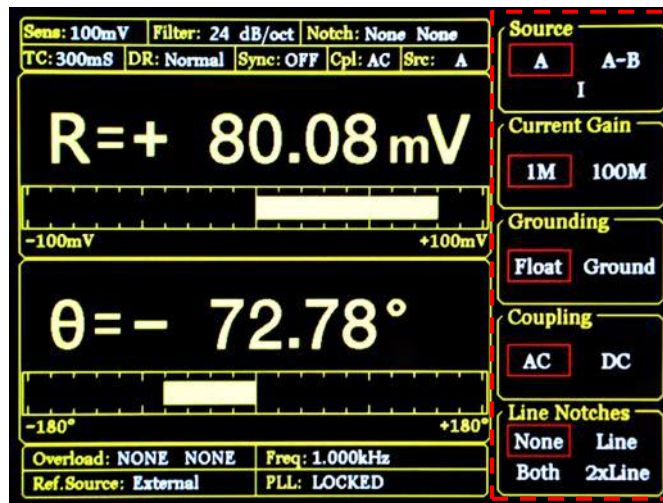

Fig.15 Main Interface: Function Bar

As is shown in Fig.15, users can choose different functions in the function bar. It's operated by 5 soft keys which are make different sense in different submenu. This is the basic way to control the system.

4. MENUS

The MENUs consists of ten parts: [INPUT/FILTERS], [REF/PHASE], [GAIN/TC], [DISPLAY], [SAVE/LOAD], [CHANNEL OUTPUT], [SAMPLE], [AUX OUTPUT], [SYSTEM] and [AUTO SET], see the front panel of OE1022 in Fig 9. Each button has an independent corresponding submenu.

4.1 [INPUT/FILTERS]

When press the [INPUT/FILTERS] button, you will enter this following submenu, as is shown in Fig.16. There are 5 function settings in this submenu, including <Source>, <Current Gain>, <Grounding>, <Coupling> and <Line Notches>.

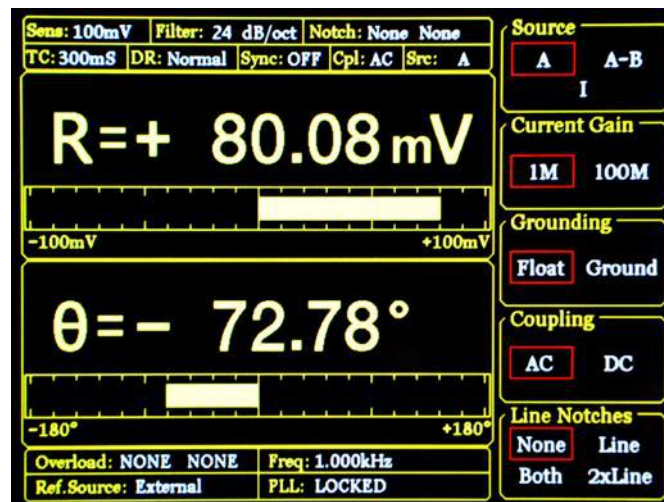

Fig16. [INPUT/ FILTERS] submenu

4.1.1 <Source>: Setting the Input Signal Mode

- <A> Single-ended voltage input mode.
- <A-B> Differential voltage input mode.
- <I> Current input mode.

Note that when choose mode <A> and mode <A-B>, the amplitude of the input signal must be less than 1Vrms.

4.1.2 < Current Gain >: Setting the Current Gain

- <1M> The input current is amplified by the gain of 10^6 V/A.
- <100M> The input current is amplified by the gain of 10^8 V/A.

4.1.3 < Grounding >: Setting the Ground Mode

- <Float> The connector shields are isolated from the chassis ground by 10kΩ.
- <Ground> The connector shields are isolated from the chassis ground by 10Ω and chassis ground is connected to the earth directly.

Generally, choose <Ground> when the current of the input signal is not large. It prevent signal drift caused by floating. Choose <Float> when there is a large potential difference between the signal ground and chassis ground and a strong current injection. This can limit the current and protect the system circuit.

4.1.4 < Coupling >: Setting the Coupling Input Mode

- <AC> AC coupling input mode. In this mode, the DC component of the input signal will be eliminated. If the signal frequency is greater than 200 Hz, <AC> should be selected.
- <DC> DC coupling input mode. In this mode, the AC component of the input signal will be eliminated. If the signal frequency is less than 200 Hz, <DC> should be chosen.

4.1.5 <Line Notches>: Setting the Status of the Notch Filters

- <None> Turn off all notch filters.
- <Line> Turn on the 50\60 Hz notch filter to suppress the power line interference.
- <2xLine> Turn on the 100\120 Hz notch filter to suppress the second harmonic interference of power.
- <Both> Turn on the 50\60 Hz and the 100\120 Hz notch filter.

Generally, if the signal frequency is greater than 200Hz, choose <Both>, <Line> or <2xLine>. Otherwise, choose <None> to avoid the amplitude damage due to small slope of the notch filter.

4.2 [REF/PHASE]

Press [REF/PHASE] and enter its submenu. There are 7 function settings in the submenu, including <Ref.phase>, <Ref.source>, <Ref.slope>, <Ref.frequency>, <Sweep>, <Harmonic> and <Sine Output>. Then choose different <Ref.source>, there will be different submenus as shown in Fig.17, Fig.18 and Fig.19.

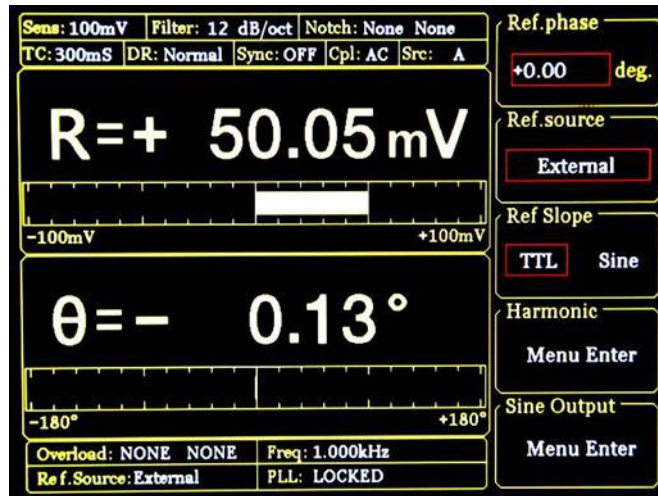

Fig.17 [REF/PHASE] Submenu-<External>.

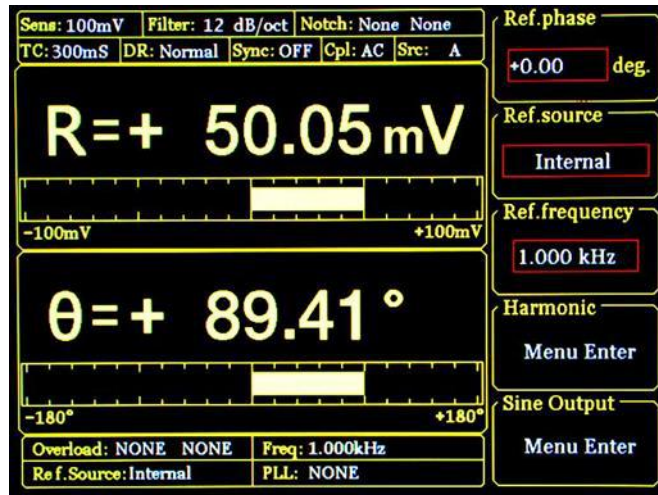

Fig.18 [REF/PHASE] Submenu-<Internal>

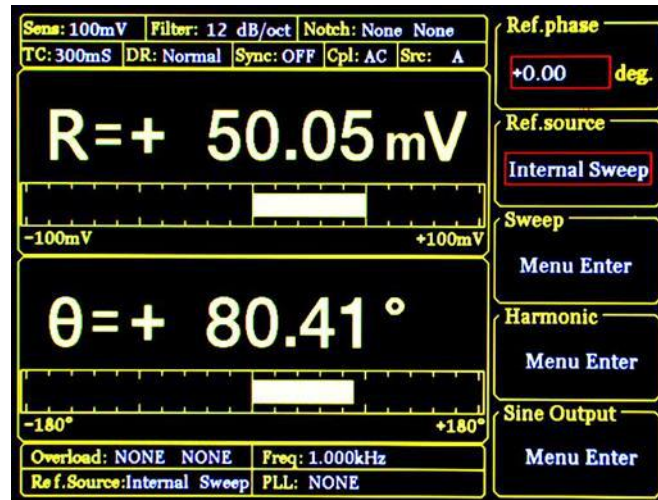

Fig.19 [REF/PHASE] Submenu-<Internal Sweep>

4.2.1 < Ref. phase >: Setting the Reference Phase

Users can set the phase shift between two orthogonal reference signals through the keyboard. The accuracy of phase is 0.01° and the range is from -180° to $+180^\circ$.

For phase, it's meaningful only when there is a reference. In the system, the default reference phase is the phase of REF IN after locked by a high precision PLL. Other phases are relative to this reference phase.

4.2.2 < Ref. source>: Setting the Reference Source

- <External> The external reference signal. <Ref.slope> can be set here.
- <Internal> The internal reference signal. In this mode, the reference signal is from the internal oscillator. The [REF IN] signal is useless. As is shown in Fig.18, <Ref.frequency> can be set.
- <Internal Sweep> The internal reference signal sweep. In this mode, the signal generator will conduct internal sweep according to the parameters set by users. As is shown in Fig.19, <Sweep> can be set.

4.2.3 < Ref. slope>: Setting the External Signal Mode

When <External> is chosen in <Ref. source>, this setting can access. Choose the corresponding signal type according to the actual external reference signal.

- <TTL> Choose TTL when the external reference signal is a square wave.
- <Sine> Choose Sine when the external reference signal is a sine wave.

If the external reference signal is TTL logic, choose <TTL>. Pay attention that, even if the REFIN is a square wave, it may still obtain an unsteady trigger because the level does not satisfy the

threshold condition of the TTL logic. Thus, it is beneficial to choose <Sine> to trigger. Moreover, choose TTL signal if the signal frequency is very low (<1Hz).

If the input reference signal is sine wave, choose SINE to trigger. In this mode, the instrument will do precision truing for the REF IN input and then detect the frequency and phase information.

Otherwise, the system has no requirement on the signal duty cycle no matter what the trigger way is. It is kind to use common 50% duty cycle.

4.2.4 < Ref. frequency>: Setting the Internal Reference Frequency

When < Internal > is chosen in <Ref. source>, this setting can access. The frequency range is from 1mHz to 102 kHz and the default frequency is 1.000 kHz. Users can set frequency through keyboard. The minimum resolution of frequency is 1mHz.

4.2.5 < Sweep>: Setting the Internal Reference Signal Sweep

When < Internal Sweep > is chosen in <Ref. source>, this setting can access. Press the <Sweep> button to access the secondary submenu. In the submenu, users can set <Sweep Type>, <Sweep Set> and <Sweep Run>, as is shown in Fig.20.

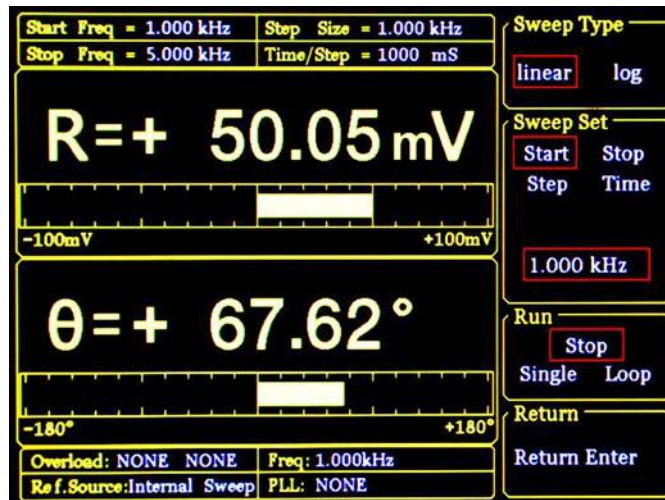

Fig.20 <Sweep> Secondary Submenu

- <Sweep Type>** Setting frequency sweep type.
 - <Linear> linear sweep type
 - <Log> logarithm sweep type

In the <Linear> mode, the step type is frequency by adding the frequency with the setting step frequency. In the <Log> mode, the step type is the percentage of frequency.

For example, in the <Log> sweep mode, the sweep step is 10% of the frequency, the start frequency is 1 kHz and the cutoff frequency is 2kHz. The process of frequency sweep is:

1000.000 Hz
 1100.000 Hz
 1210.000 Hz
 1331.000 Hz
 1464.000 Hz
 1610.510 Hz
 1771.561 Hz
 1948.717 Hz
 2000.000 Hz

- <Sweep Set>** Setting frequency sweep parameters.
- <Start>** the start frequency of sweep
 - <Stop>** the cutoff frequency of sweep
 - <Step>** in the **<Linear>** mode, the **<Step>** is the step frequency; in the **<Log>** mode, the **<Step>** is the percentage of frequency.
 - <Time>** The step time interval of sweep.

Setting the start frequency, cutoff frequency, step frequency and time through keyboard and soft keys. The range of start frequency and cutoff frequency is from 1mHz to 102kHz. **<Start>** frequency is 1.000kHz in default and **<Stop>** frequency is 5.000kHz in default. The minimum resolution of the frequency is 1mHz. In the **<Log>** mode, the minimum resolution of the step is 0.001% of the frequency, and the minimum/maximum resolution of the step time is 1mS/100S.

- <Sweep Run>** Setting frequency sweep running mode
- <Stop>** stop sweep
 - <Single>** single sweep
 - <Loop>** loop sweep

When start from **<Single>** sweep, OE1022 does an internal frequency sweep according to the settings of users. After that, the status jumps back to **<Stop>** automatically.

When start from **<Loop >** sweep, OE1022 does constant loop sweep until users switch the status to **<Stop>** manually.

4.2.6 <Harmonic>: Setting the Harmonic Detection

The OE1022 allows simultaneous measurement of two harmonics. The harmonic setting interface is shown in Fig.21.

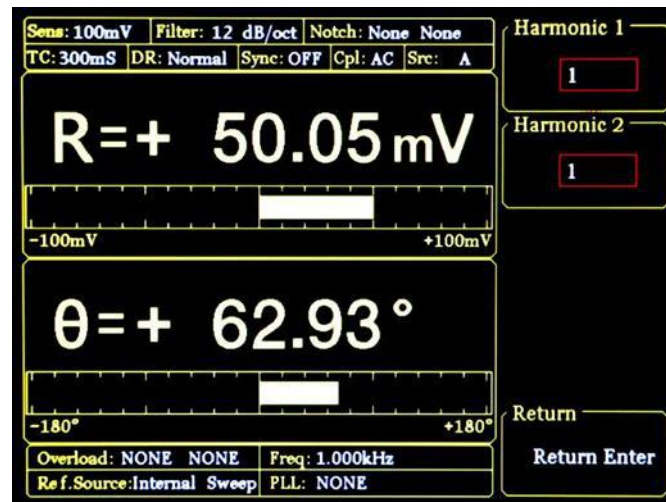

Fig.21 <Harmonic> Secondary Submenu

<Harmonic 1> Setting harmonic 1. The minimum value is 1 and the maximum value is 32767.

<Harmonic 2> Setting harmonic 2. The minimum value is 1 and the maximum value is 32767.

Enter the order of harmonic through keyboard. The default order is 1 and it means detecting 1 order harmonic (fundamental wave). The limitation of the harmonic setting is (Harmonic * Freq) < 102kHz, where Freq means the reference frequency. Once beyond the limit, system will reduce the order of harmonic automatically to meet the conditions. At the same time, when the order is set 0, the system will set the order to 1 automatically

For example, the input signal is 1kHz square wave. Suppose that the signal's amplitude is A. Set <Harmonic> as 1, 2, 3, 4, 5, 6..., the R will be 0.45A, 0, 0.15A, 0.09A, 0...respectively. This sequence is A times higher the coefficient sequence of the square wave Fourier Series.

It is necessary to set <List> in the <Full> option of the <Display> submenu during detecting double harmonic.

4.2.7 <Sine Output>: Setting the Sine Output

OE1022 can output sine wave whose amplitude range is from 0V to 5V through the "Sine Out" BNC connector on front panel. In its secondary submenu, users can set <Sweep Type>, <Voltage>, <Sweep Set> and <Sweep Run>. Besides, there are 3 modes to choose in <Sweep Type>, including <Fixed> - fix the output amplitude, <Linear> linear sweep output and <Log>

logarithm sweep output. When choosing different <Sweep Type>, the submenu is different as is shown in Fig.22 and Fig.23.

When using the <External> reference, <Sine Output> provides a sine signal which locks phase with external reference. When using the <Internal> reference, the reference signal is generated by the oscillator in OE1022. The “TTL OUT” BNC connector on rear panel will output TTL signal which is synchronous with the <Sine Output>.

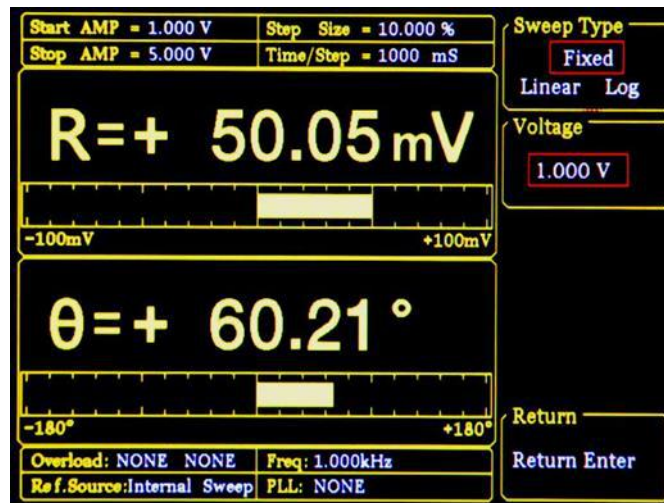

Fig.22 <Sine Output> Secondary Submenu-<Fixed>

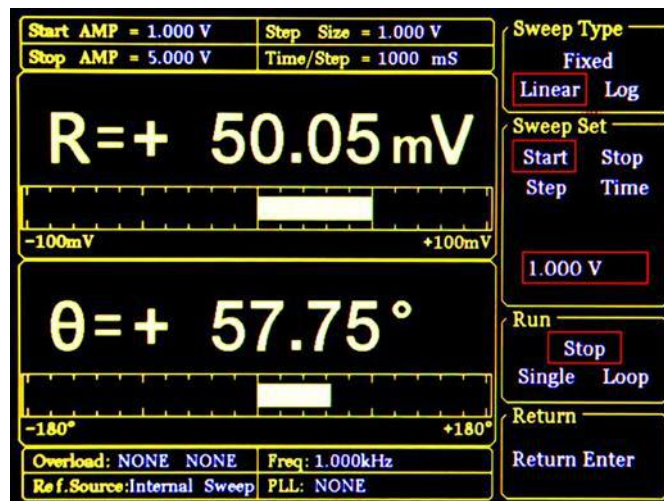

Fig.23 <Sine Output> Secondary Submenu-<Linear & Log>

- <Sweep Type> Setting amplitude sweep type.
- <Fixed> fixed amplitude sweep type(default)
 - <Linear> linear amplitude sweep type
 - <Log> logarithm amplitude sweep type

In <Fixed> mode, the amplitude of <Sine Output> is set by users. In <Linear> or <Log> mode, settings are configured in <Sweep Set> and <Sweep Run>.

<Voltage> Setting the amplitude of sine output

In <Fixed> mode, users can set the amplitude of sine out through keyboard. The range is from 0.001 Vrms to 5 Vrms and the minimum resolution is 0.001Vrms.

<Sweep Set> Setting the parameters of amplitude sweep.

 <Start> the start amplitude of sweep

 <Stop> the cutoff amplitude of sweep

 <Step> in <Linear> mode, the <Step> is the step amplitude of sweep; in the <Log> mode, the <Step> is the percentage of amplitude.

 <Time> the step time interval of sweep.

Users can set the start amplitude, cutoff amplitude, step and time through keyboard and soft keys. The range of amplitude is from 0.001 Vrms to 5 Vrms. The default start amplitude is 1.0 Vrms and cutoff amplitude is 5.000 Vrms. The minimum resolution of amplitude is 0.001 Vrms.

In <Log> mode, the minimum resolution of step is 0.001% and the minimum/maximum resolution of the step time is 1ms/100,000ms.

<Sweep Run> Setting amplitude sweep run mode

 <Stop> stop sweep

 <Single> single sweep

 <Loop> loop sweep

When start from <Single> sweep, OE1022 does an internal amplitude sweep according to the settings of users. After that, the status jumps back to <Stop> automatically.

When start from <Loop > sweep, OE1022 does constant loop sweep until users switch the status to <Stop> manually.

4.3 [GAIN/TC]

Press [GAIN/TC] button, then enter the submenu as is shown in Fig.24. There are 5 function settings in the submenu, including <Sensitivity>, <Reserve>, <Time Constant>, <Filter dB/oct> and <Synchronous>.

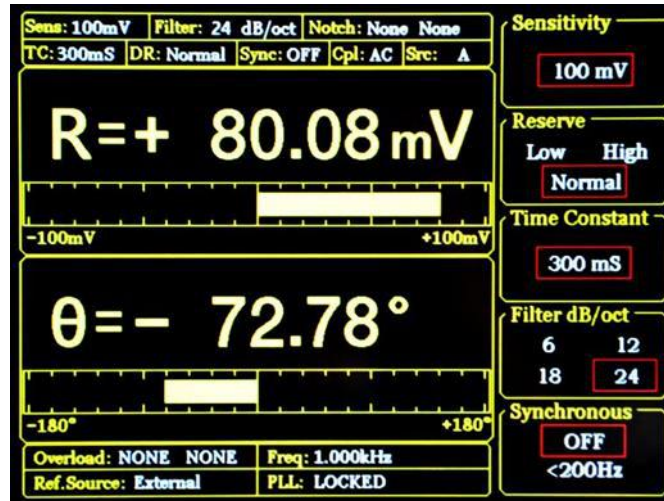

Fig.24 [GAIN/TC] Submenu

4.3.1 <Sensitivity>: Setting the Full Scale Sensitivity

Choose an appropriate full-scale sensitivity according to the amplitude of the input signal. Adjust the value through the soft keys or spin knob.

1 nV/fA	200 nV/fA	50 μ V/pA	10 mV/nA
2 nV/fA	500 nV/fA	100 μ V/pA	20 mV/nA
5 nV/fA	1 μ V/pA	200 μ V/pA	50 mV/nA
10 nV/fA	2 μ V/pA	500 μ V/pA	100 mV/nA
20 nV/fA	5 μ V/pA	1 mV/nA	200 mV/nA
50 nV/fA	10 μ V/pA	2 mV/nA	500 mV/nA
100 nV/fA	20 μ V/pA	5 mV/nA	1 V/ μ A

The change of <Sensitivity> will change the dynamic range of the system. Besides, it will impact the output of CH1&CH2. If the measure signal is current, the full scale acts as the corresponding current unit, <100mV/nA> in default.

When choose <AUTO GAIN>, the system will automatically adjust the sensitivity according to R value of input signal. Note that if the time constant is very large, the system will need a long time to adjust.

4.3.2 <Reserve>: Setting the Dynamic Reserve Mode

- <Low> Low dynamic reserve mode
- <High> High dynamic reserve mode.
- <Normal> Normal dynamic reserve mode. Generally, this mode is recommended.

When choose <AUTO RESERVE>, the system will automatically adjust the minimum dynamic range required according to the R value of input signal.

4.3.3 < Time Constant >: Setting the Time Constants

The range of time constant is from 10 us to 3000 s. Adjust the value through soft keys and spin knob.

10 μ s	3 ms	1 s	300 s
30 μ s	10 ms	3 s	1000 s
100 μ s	30 ms	10 s	3000 s
300 μ s	100 ms	30 s	
1 ms	300 ms	100 s	

The greater the time constant, the smaller the ENBW, the longer the system response and the higher the measurement accuracy.

4.3.4 < Filter dB/oct >: Setting the Roll off Slope of the Low Pass Filter

- <6dB/oct> The roll off slope is 6 dB/oct.
- <12dB/oct> The roll off slope is 12 dB/oct.
- <18dB/oct> The roll off slope is 18 dB/oct.
- <24dB/oct> The roll off slope is 24 dB/oct.

At the same measurement accuracy, a greater roll off slope can reduce the time constant, making a faster response.

4.3.5 < Synchronous >: Setting the Status of the Synchronous Filter

- <OFF> Close the synchronous filter.
- <200Hz> Open the synchronous filter. It's useful at a low reference frequency (< 200 Hz). When the input signal frequency is very low, the low pass filter can't get stable results or it needs a long time to do that. At this time, synchronous filter helps.

Note that if the synchronous filter is open, <Filter dB/oct> must be <18 dB/oct> or <24

dB/oct >!

4.4 [DISPLAY]

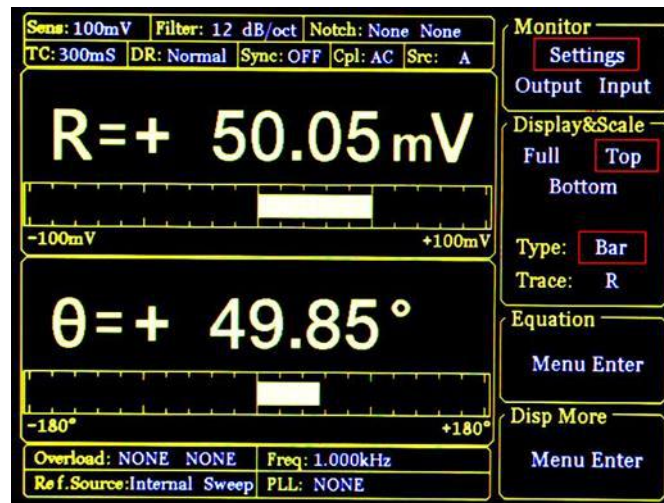

Fig.25 [DISPLAY] Submenu

Press [DISPLAY] button and enter the submenu as is shown in Fig.25. In this submenu, there are 4 function settings: <Monitor> <Display & Scale> <Equation> and <Disp More>. They can be chosen and set by the soft keys beside the submenu.

4.4.1 < Monitor >: Setting Status Bar Display

- <Settings> The current setting parameters and status will be shown in the status bar at the top left of the screen, such as <Sensitivity>, <Filter> and so on.
- <Output> The real-time values of <R>, <X>, <Y> and <θ> will be shown in the status bar.
- <Input> The real-time values of <AD1>, <AD2>, <AD3> and <AD4> of the AUX_ADC output on rear panel will be shown in the status bar.

4.4.2 < Display & Scale >: Setting the Dynamic Area Display

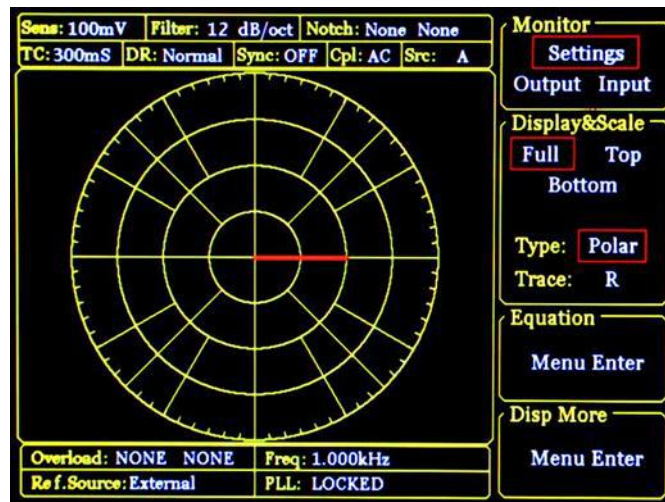

Fig.26 <Full>-<Polar> Display

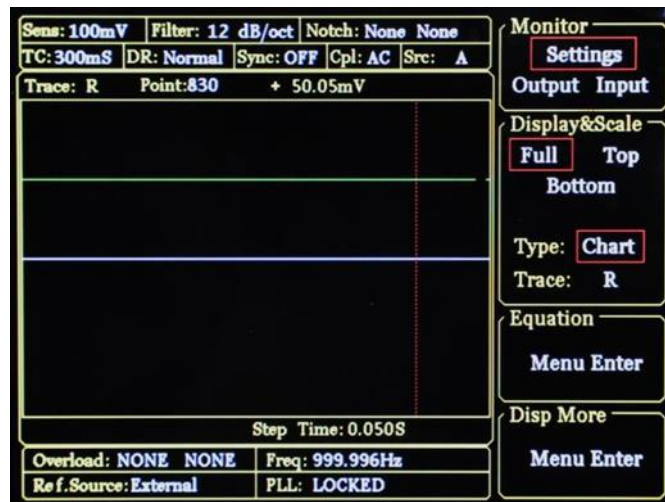

Fig.27 <Full>-<Chart> Display

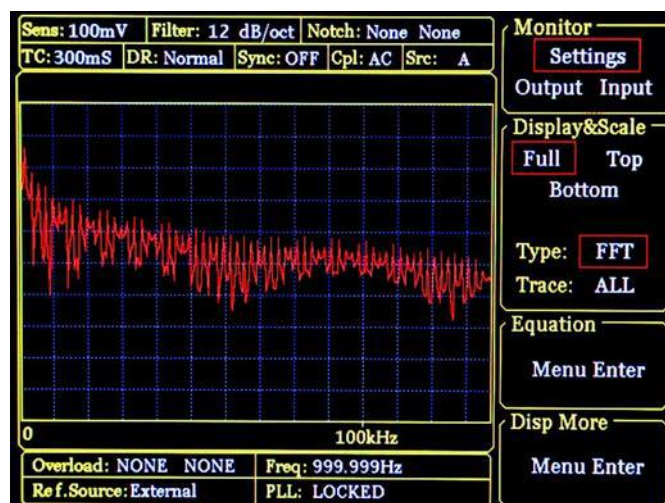

Fig.28 <Full>-<FFT> Display

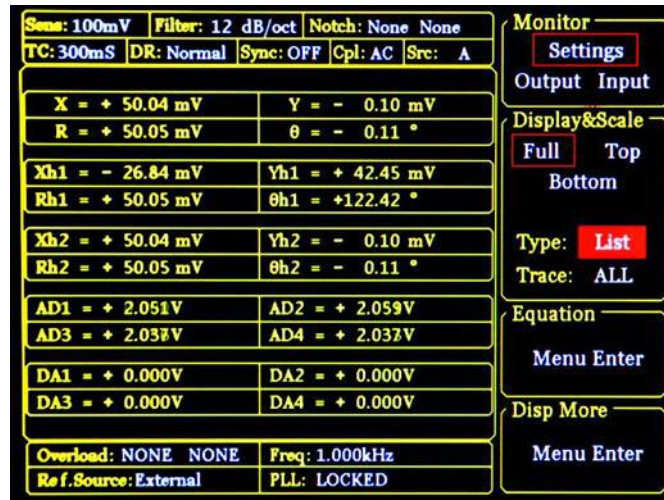

Fig.29 <Full>-<List> Display

<Display & Scale> is used to set the display area and type of measurement results, including two submenus: <Area> and <Type/Trace>.

<Area>: Setting Display Area

<Full>

Full display mode displays in the whole dynamic area. It has 4 display types, including <Polar>, <Chart>, <FFT> and <List>.

1) <Polar>: polar chart

The length of graphic pointer depends on the actual <R> while the angle depends on < θ >, as is shown in Fig.26. Besides, the values of <X> and <Y> are visible. It's very convenient and intuitive.

2) <Chart>: XY coordinates chart.

It displays the curve of the measurement results. Users can watch the value of sample points by controlling <Cursor> through spin knob. <Chart> always picks up the measured data cooperating with [SAMPLE] submenu and [CONTROL] area, as is shown in Fig.27.

3) <FFT>: spectrum map.

Compute the spectrum information of the input signal by FFT and display it, as is shown in Fig.28.

4) <List>: display the value of the fundamental wave and two harmonics of the input signal and AUX_ADC, AUX_DAC on rear panel at the same time. The interface is shown in Fig.29.

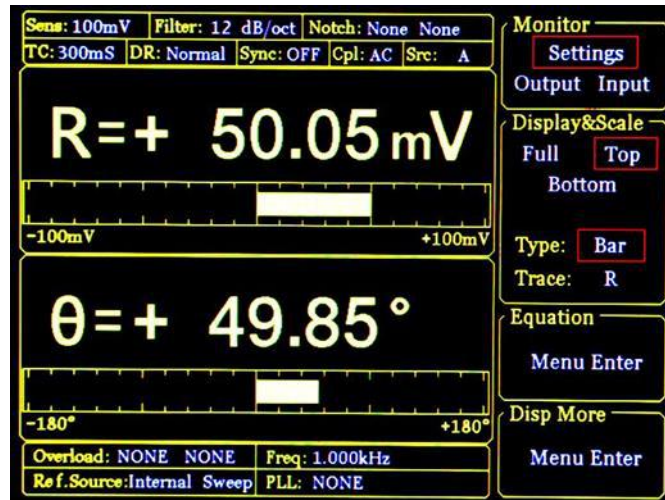

Fig.30 <Top>-<Bar> Display

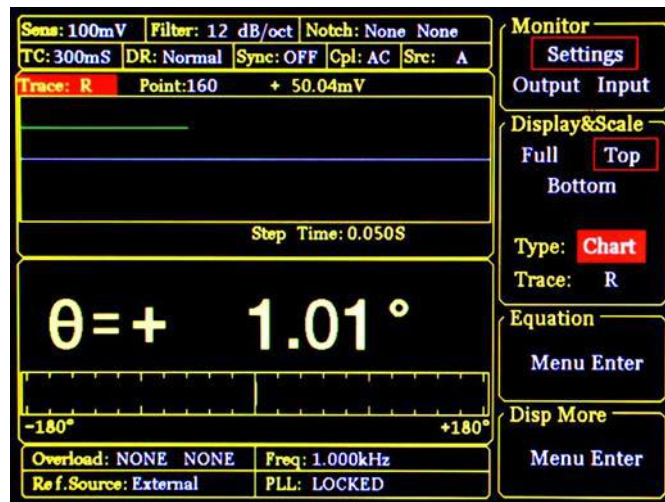

Fig.31 <Top>-<Chart> Display

- <Top> Only choose the top area to set. When <Type> or <Trace> is changed, the display way of top area will change, as is shown in Fig.30 and Fig.31. There are two choices in <Type>, including <Bar> and <Chart>. If <Type> chooses <Bar>, <Trace> provides options, including fundamental wave, harmonic, and Equation. If <Type> chooses <Chart>, <Trace> provides options: <Buffer1>, < Buffer2>, < Buffer3> and < Buffer4>. <Buffer> is set by <Select> submenu of <SAMPLE>.
- <Bottom> Only choose the bottom area to set. When <Type> or <Trace> is changed, the display way of bottom area will change, just like the <Top> mode.
- <Type/Trace> **Setting the way of display**
Switch <Type> or <Trace> to set by soft keys. The chosen one will be highlighted and then switch the wanted mode through knob.
- <Type> How to display. Users can choose <polar> (polar coordinates), <chart> (XY coordinates) and <Bar> (number percentage). Besides, <FFT> and

<LIST>	are optional in the <Full> mode.
<Trace>	What to display. Users can choose the values to display as the following.
<X>	The X value of fundamental wave of the input signal.
<Y>	The Y value of fundamental wave of the input signal.
<R>	The R value of fundamental wave of the input signal.
<θ>	The θ value of fundamental wave of the input signal.
<Xh1>	The X value of 1 th channel harmonic of the input signal.
<Yh1>	The Y value of 1 th channel harmonic of the input signal.
<Rh1>	The R value of 1 th channel harmonic of the input signal.
<θh1>	The θ value of 1 th channel harmonic of the input signal.
<Xh2>	The X value of 2 th channel harmonic of the input signal.
<Yh2>	The Y value of 2 th channel harmonic of the input signal.
<Rh2>	The R value of 2 th channel harmonic of the input signal.
<θh2>	The θ value of 2 th channel harmonic of the input signal.
<E1>	The 1 th Equation value.
<E2>	The 2 th Equation value.
<E3>	The 3 th Equation value.
<E4>	The 4 th Equation value.

4.4.3 < Equation >: Setting the Equation.

The function of <Equations> is to do basic proportional calculation with the measurement values. The results output through CH1/CH2 BNCs on front panel. The equation is fixed:

$$\text{Equation} = \frac{A \times B}{C}$$

A, B and C is set in the secondary submenu of <Equation> can there are 4 equations can be set in this menu, as is shown in Fig.32.

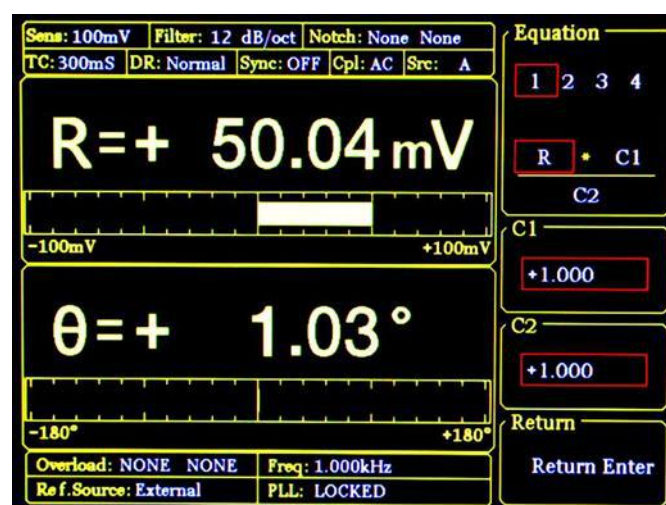

Fig.32 <Equation> Secondary Submenu

<Equation> Setting equation parameters.
 The value of A, B and C in equation1~4=A*B/C can be changed through soft keys. The optional values of A, B and C include fundamental wave, harmonic wave, ADC, frequency and constant parameters.
 For example, when A is R=50mV, B is $\theta=130^\circ$, C is Freq=1 kHz, then

$$\text{Equation} = \frac{A \times B}{C} = \frac{0.05 \times 130}{1000} = 0.0065$$

When <Trace> in [DISPLY] submenu choose <E1>, the result of Equation

1 will be displayed. In <Bar> display mode, the display range is from 0.000001 to 9999999 without unit and progress bar.

When <Source> in [CHANNEL OUPUT] submenu choose <E1>, the result of Equation 1 will output. More details are in [CHANNEL OUPUT] submenu.

<C1> Setting constant parameter 1.
 Constant parameter <C1> setting, range: -10~+10.

<C2> Setting constant parameter 2.
 Constant parameter <C2> setting, range: -10~+10.

4.4.4 < Disp More >: More Display Settings

<Disp More> secondary submenu adds two settings, <Range> and <Curve Point>, as is shown in Fig.33.

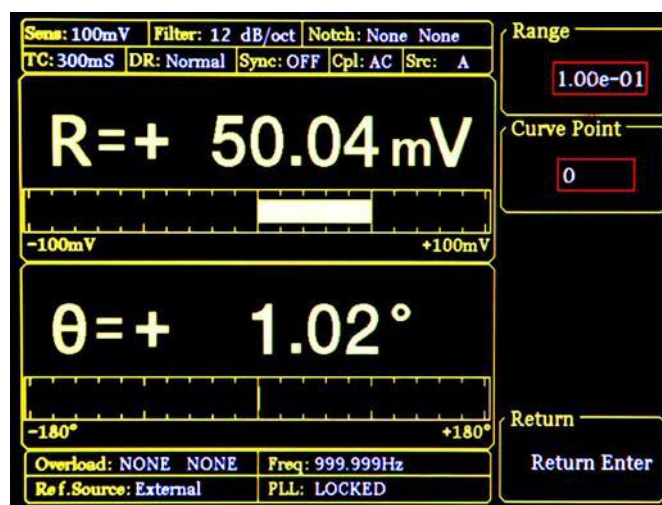

Fig.33 <Disp More> Secondary Submenu

<Range> Setting display range
 <Range> is used to set the largest scale of <Bar>, <Chart> and <Polar> chart.
 The input range of <Range> is 1 nV to 1 V. This range will change in sync with the change of <Sensitivity>. Besides, it can be set numerically

through the keyboard. For example, 1.00e-01 means $1.00 \times 10^{-1} \text{V}$ that is 100mV.

Keep <Sensitivity> unchanged and then change the value of <Range>. Set <Range> 1.00e-03=1mV, then the display range is -1mV to +1mV.

- <Curve Point> Setting the position of sampling curve
- In <Curve Point> mode, the <Cursor> in <Chart> can rapidly locate position and watch the value of this point. The setting range of <Curve Point> is 1~16384.
- When <Chart> is in reset mode (no store data), the <Curve Point> makes no sense and keeps 0. When sampling data, this option will be hidden (can't use). It will be displayed after pause.
- Before using <Curve Point>, users should callout <Cursor> by pressing the [CURSOR] button in CONTROL area.

4.5 [SAVE/RECALL]

Press [SAVE/RECALL] button and enter the submenu as is shown in Fig.34.

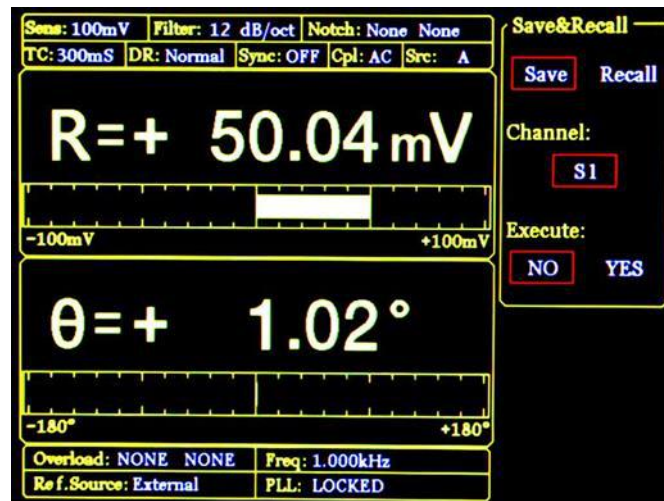

Fig.34 [SAVE/RECALL] Submenu

[SAVE/RECALL] menu is mainly used to save and recall the setting parameters and status. Users can save in <S1>, <S2>, <S3> and <S4> according to their individual favorites. As is shown in Fig.34, <Save & Recall> choose <Save>, <Channel> chooses <S1>, <Execute> choose <YES>, and then the current setting parameters and status will be saved in <S1>. In this case, the current parameters and status can be save in <S1>. <Save & Recall> choose <Recall>, <Channel> chooses <S1> and <Execute> choose <YES> to recall the archive. In this case, the data in <S1> can be recalled.

4.6 [CHANNEL OUTPUT]

Press [CHANNEL OUTPUT] button and enter the submenu as is shown in Fig.35.

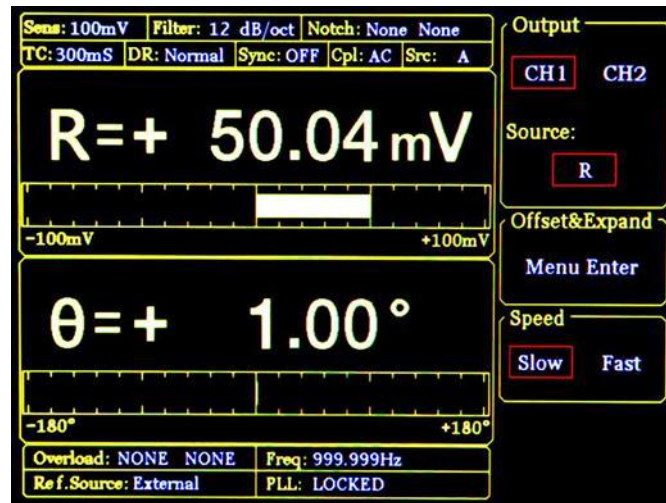

Fig.35 [CHANNEL OUTPUT] Submenu

The two BNCs CH1 and CH2 can output R, X, Y and θ that users wanted by setting in the [CHANNEL OUTPUT] submenu. The output offset and expand is set in <Offset & Expand>. In <Speed>, users can set the output rate of channel.

The calculation equation of output signal is:

1. When source is <R>, <X>, <Y>, <Rh1>, <Xh1>, <Yh1>, <Rh2>, <Xh2>, <Yh2> or <Noise>:

$$\text{output} = \left(\frac{\text{Signal}(\text{source})}{\text{Sens}} + \text{offset} \right) \times \text{Expand} \times 10V$$

2. When source is <θ>, <θh1>, <θh2>

$$\text{output} = \frac{\text{Signal}(\text{source})}{180^\circ} \times 10V$$

3. When source is <E1>~<E4>(Equation), in addition to the two equations above, there are other options as below:

- a) AUX_IN1~AUX_IN4: output = the input voltage.
- b) Constant coefficient: directly correspond. Such as 10 corresponds to 10V, -5 corresponds to -5V.
- c): frequency:

Every stage of the frequency is from 5V to 10V. For example,

- 1000Hz = 5 V
- 1200Hz = 6 V
- 1600Hz = 8 V
- 1800Hz = 9 V
- 1990Hz = 9.95 V
- 2000Hz = 5 V (next stage)

The frequency is divided as the following stages:

- 62.5 Hz – 125 Hz
- 125 Hz – 200 Hz

250 Hz – 500 Hz
500 Hz – 1000 Hz
1 kHz – 2 kHz
4 kHz – 8 kHz
8 kHz – 16 kHz
...

Equation is calculated by the above formulas users choose, and then calculate the final result according to the Equation formula itself. The range of result is from -10 V to +10 V.

4.6.1 < Output Source >: Setting Output Source

<X>: the corresponding analog level of the channel output X
<Y>: the corresponding analog level of the channel output Y
<R>: the corresponding analog level of the channel output R
< θ >: the corresponding analog level of the channel output θ
<Xh1>: the corresponding analog level of the channel output Xh1
<Yh1>: the corresponding analog level of the channel output Yh1
<Rh1>: the corresponding analog level of the channel output Rh1
< θ h1>: the corresponding analog level of the channel output θ h1
<Xh2>: the corresponding analog level of the channel output Xh2
<Yh2>: the corresponding analog level of the channel output Yh2
<Rh2>: the corresponding analog level of the channel output Rh2
< θ h2>: the corresponding analog level of the channel output θ h2
<E1>: the corresponding analog level of the channel output E1
<E2>: the corresponding analog level of the channel output E2
<E3>: the corresponding analog level of the channel output E3
<E4>: the corresponding analog level of the channel output E4
<Noise>: the corresponding analog level of the channel output Noise

4.6.2 < Offset & Expand >: Setting the Offset and Expand

Choose the <Offset & Expand> and enter the secondary submenu, as is shown in Fig.36.

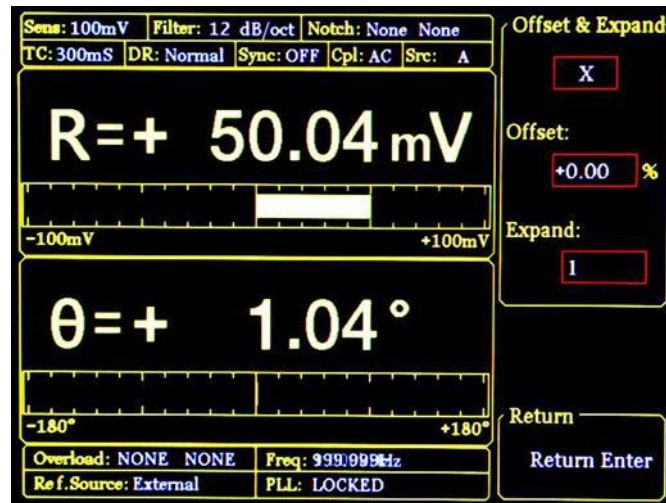

Fig.36 <Offset & Expand> Submenu

<Offset> setting: It is set through keyboard. The adjustable range is -100%~+100%. The minimal step is 0.01% and 0.00% is default.

<Expand> setting: It is set through keyboard. The adjustable range is 1~256 and 1 is default. If the setting value of Expand causes the calculation result over ±10V, the output will be seriously affected.

The settings of <Offset> and <Expand> will not affect the data display in dynamic area.

4.6.3 < Speed >: Setting the Output Speed

- <Slow> the data output speed of channel CH1 & CH2 is 10 Hz
- <Fast> the data output speed of channel CH1 & CH2 is 312.5 kHz

4.7 [SAMPLE]

[SAMPLE] submenu is used to control the sampling and storage. There are 5 settings in this submenu, including <Step Time>, <Length>, <Select>, <Trigger Mode> and <Sample Mode>, as is shown in Fig.37.

The setting of [SAMPLE] menu should cooperate with the keys in CONTROL area. In this case, [SAMPLE] can control the sample to start, pause and reset.

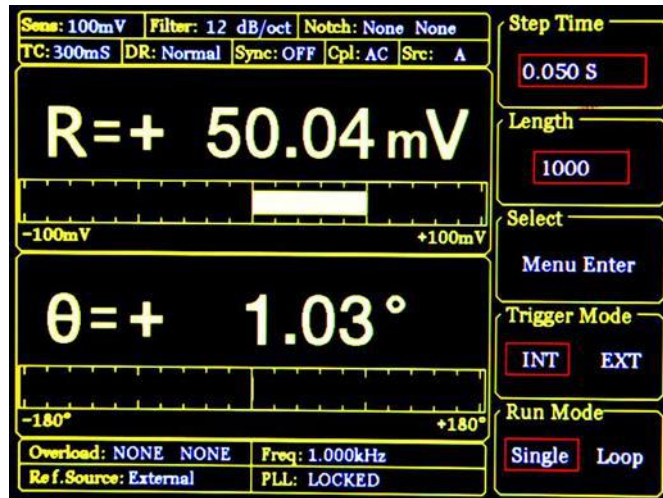

Fig.37 [SAMPLE] Submenu

4.7.1 < Step Time >: Setting the Step Time

Setting the step time, range: 1ms~ 100,000ms, collect one data at every step time.

4.7.2 < Length >: Setting the Sample Length

Setting the sample data length, range: 1~16384

When the data sampling is being executed, if the <Length> value is set smaller than the length of the current sampling, sampling will stop immediately in single sample mode. But in the loop sample mode, sampling will start again from the first point.

4.7.3 < Select >: Setting the Sampling Object

The <Select> secondary menu is shown in Fig.38.

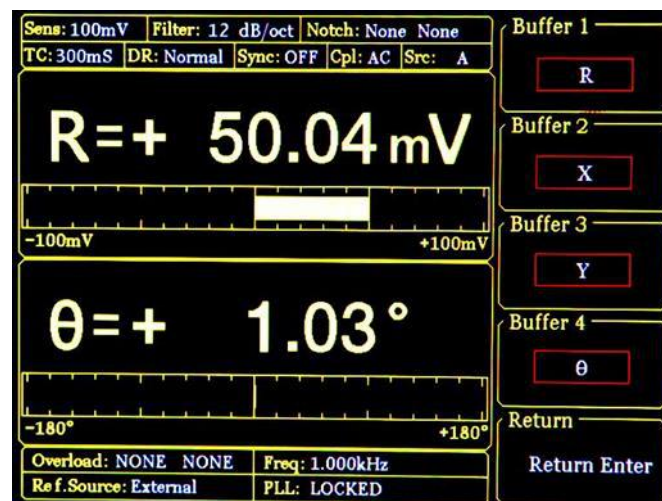

Fig.38 <Select> Secondary Submenu

<Buffer1~4> Setting the 4 sampling buffers

There are 4 internal <Buffer> in OE1022. Each buffer can store 16384 32-bits-data. Each buffer can store any one of the following parameter, including <R>, <X>, <Y>, < θ >, <R>, <X>, <Y>, < θ >, <R>, <X>, <Y>, < θ >, <Noise>, <E1>, <E2>, <E3>, <E4>, <A1>, <A2>, <A3>, <A4> and <Freq>.

Only when the sampling restart, the setting of <buffer> is effective. The choice of <buffer> will affect the <Trace> options in <Chart> display mode. In <Chart> display mode, <Trace> can only choose what is chosen in <Buffer>.

4.7.4 < Trigger Mode >: Setting Trigger Mode

<INT> internal trigger mode
<EXT> external trigger mode

In the <INT> mode, the sampling step time is generated by the instrument through setting <Sampling Time>.

In the <EXT> mode, the sampling pulse is input from BNC TRIG_IN on rear panel. Sample a point at each sampling pulse and the sampling rate is not more than 500 Hz.

Internal trigger mode and external trigger mode both control the sampling to start, stop or reset through the buttons in CONTROL area.

4.7.5 < Sample Mode >: Setting Sample Mode

<Single> single sample mode
<Loop> loop sample mode

In <Single> mode, the system will automatically stop after completing one data collection and wait for a next start. In <Loop> mode, the system will loop sampling automatically and cover the original sampling results.

Single and loop sample mode both control sampling to start, stop or reset through the buttons in CONTROL area.

4.8 [AUX OUTPUT]

There are 4 options in the [AUX OUTPUT] submenu, including <DA1 Output>, <DA2 Output>, <DA3 Output> and <DA4 Output>. These 4 options are corresponding to the 4 AUX_DAC output. The output range is $\pm 10V$ and the output is 0.000V in default. The interface is shown in Fig.39.

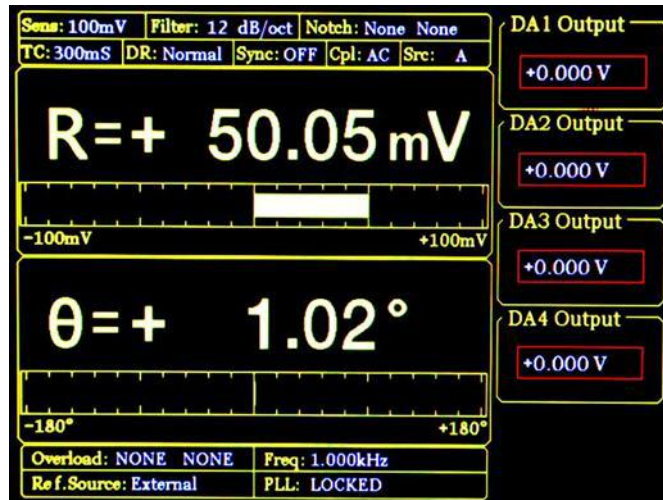

Fig.39 [AUX OUTPUT] Submenu

- <DA1 Output> The first channel output of AUX DAC, corresponding to AUX_DAC1 on rear panel.
- <DA2 Output> The second channel output of AUX DAC, corresponding to AUX_DAC2 on rear panel.
- <DA3 Output> The third channel output of AUX DAC, corresponding to AUX_DAC3 on rear panel.
- <DA4 Output> The fourth channel output of AUX DAC, corresponding to AUX_DAC4 on rear panel.

4.9 [SYSTEM]

[SYSTEM] submenu includes the system information and settings of OE1022, like instrument information, screen brightness and the settings of RS232 communications, as is shown in Fig.40.

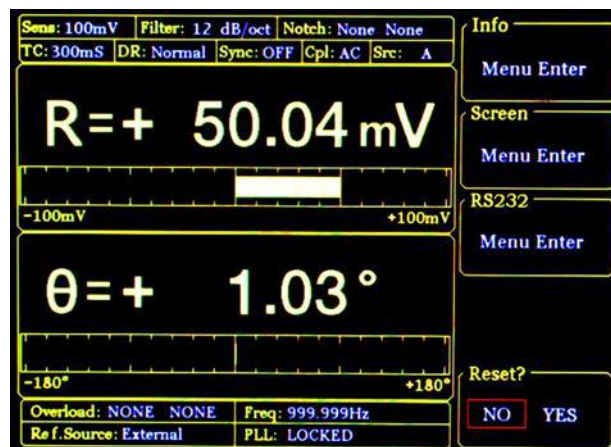

Fig.40 [SYSTEM] Submenu

4.9.1 < Info >: Setting the Parity Mode

Choose <Info> to enter a secondary submenu shown in Fig.41. This submenu displays related

information about the R & D unit of the instrument.



Fig.41 <INFO>-Submenu

Choose <Version> and the interface displays the version of OE1022, as is shown in Fig.42.

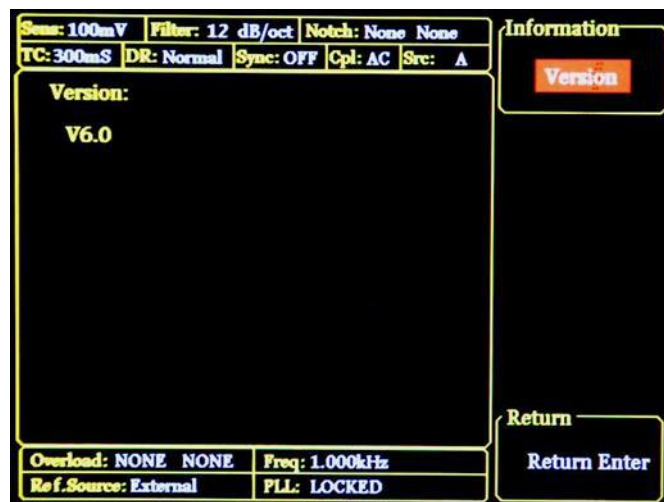

Fig.42 <INFO>-Version

Choose <Contact> and the interface displays contact information as is shown in Fig.43.



Fig.43 <INFO>-Contact Information

4.9.2 < Screen > Submenu

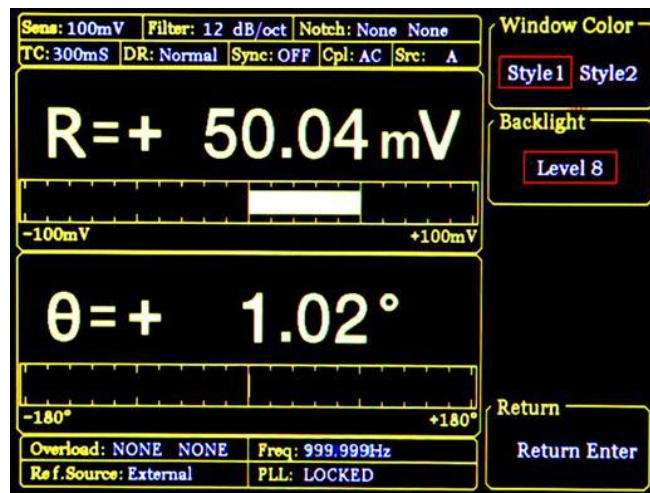

Fig.44 <Screen> Submenu-<Style 1>

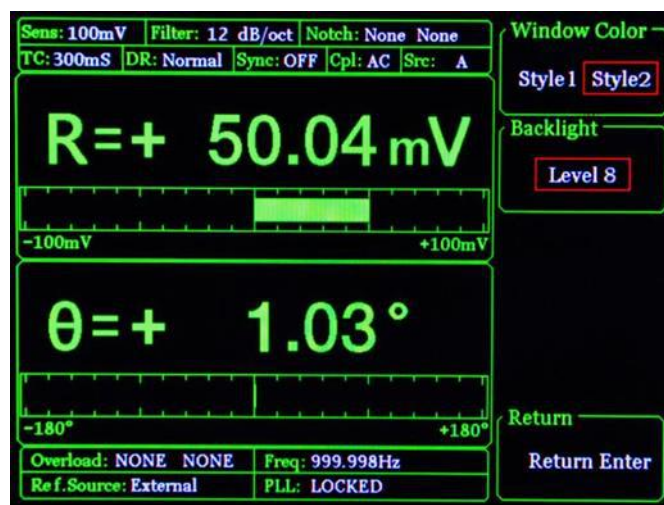

Fig.45 <Screen> Submenu-<Style 2>

Choose <Screen> to enter this interface, as is shown in Fig.44 and Fig.45.

This submenu includes two function settings, <Window Color> and <Backlight>.

- <Window Color> setting the window color
 - <Style 1> the window main color is yellow
 - <Style 2> the window main color is green
- <Backlight> setting the brightness of backlight
 - the bright levels can vary from <Level 1> to <Level 8> through Spinning the knob

4.9.3 < RS232 >: Setting the RS232 Mode

Choose the <RS232> secondary submenu to enter Fig.46.

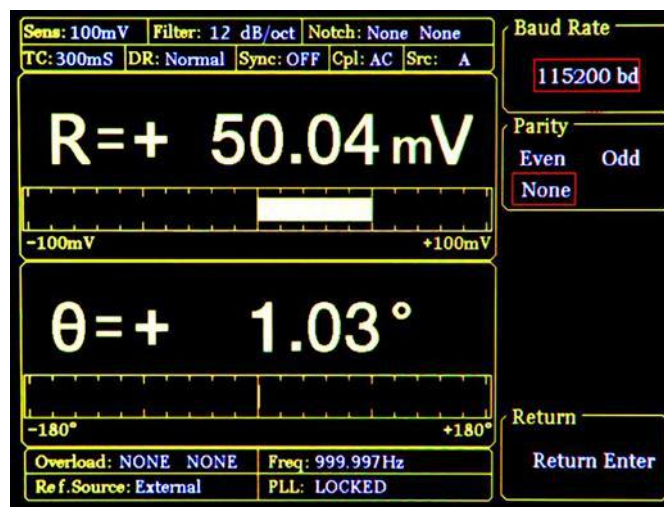

Fig.46 <RS232> Submenu

There are 3 function settings in the submenu, including <Baud Rate>, <Word Length> and <Parity>.

- <Baud Rate> setting the baud rate
 - Press the corresponding soft keys and knob to adjust the baud rate. The value can be set as <600>, <1200>, <2400>, <9600>, <19200>, <38000>, <43000>, <56000>, <57600>, <115200>, <230400>, <380400>, <460800> and <921600>.

- <Parity> setting the parity
 - <Even> Even
 - <ODD> Odd
 - <NONE> nothing

Note that using <USB> and <RS232>, the local OE1022 can communicate with another OE1022 or the PC. More details are talked at '5 REMOTE PROGRAMMING'.

4.9.4 <Reset? >: The Lock-in Reset

Press the corresponding soft key and the system will be restarted.

4.10 [AUTO SET]

There are 4 settings in [AUTO SET] submenu, including <Auto Reserve>, < Auto Gain>, < Auto Phase > and < Auto Scale >, as is shown in Fig.47.

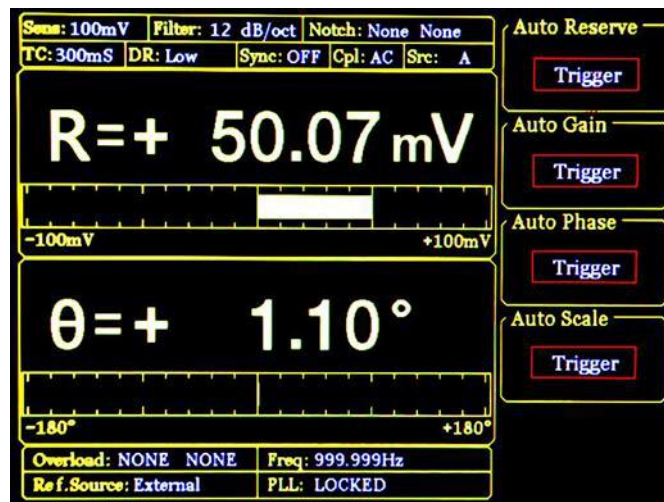

Fig.47 [AUTO SET] Submenu

4.10.1 < Auto Reserve >: Setting the Dynamic Reserve Automatically

Press the < Auto Reserve > button, the system will automatically change the settings of <Reserve> according to the current signal. The principle is to select the minimum dynamic reserve of the current measurement signal.

4.10.2 < Auto Gain >: Setting the Sensitivity Automatically

Press the < Auto Gain> button, the system will automatically change the setting of <Sensitivity> according to the current R. The principle is that the system should choose an appropriate <Sensitivity> but no more than the maximum sensitivity. The < Auto Gain > function in OE1022 needs some response time (generally less than 5s). If the current R fluctuates a lot, the setting for < Auto Gain > might be fail. In this case, users should switch current menu to the [GAIN/TC] submenu and set the R manually.

4.10.3 < Auto Phase >: Setting Phase Shift Automatically

Press the < Auto Phase > button and the system will adjust the phase shift of the reference signal to make the phase of the input signal 0. This < Auto Phase > function needs some response time (generally less than 10s). If the current θ fluctuates a lot, the setting for < Auto Phase > might be fail. In this case, users should switch the current menu to [REF/PHASE] submenu and set θ manually.

4.10.4 < Auto Scale >: Setting Scale Automatically

Press the <Auto Scale> button and the system will adjust the scale according to R to make the displayed value large enough within the range. This < Auto Scale > function only has effect on display. The input and output will not be affected. The scale can also be set through <Range> in the [DISPLAY] submenu.

4.11 [CONTROL]

There are 4 buttons in [CONTROL] area, including [START CONT], [PAUSE CLEAR], [CURSOR] and [ACTIVE CHART]. The [CONTROL] menu, cooperation with [SAMPLE] menu and <CHART>, controls the data sampling to start, pause, reset and also chooses the [CURSOR] and <Chart> to display or not.

4.11.1 < START/CONT >: Start or Continue Data Sampling

The [START/CONT] button has two functions. One is to start a new sampling [START], another is to continue the paused sampling [CONTINUE].

Sampling is start and the measured data will be stored in internal buffer as the sampling rate set in [SAMPLE] menu. If in the <Chart> mode, the sampled data will be displayed on <Chart> simultaneously. Otherwise, data will be stored.

In single sampling mode, the sampling will stop automatically when the number of sampling points reaches the sampling length. When sampling is stopped, press the [START] button and the system will start sampling again from the beginning until the ending point stops.

If press the [PAUSE] button when the sampling is executing. Sampling will be paused. In this case, press the [START/CONT] button and the sampling will be continued.

4.11.2 < PAUSE/CLEAR >: Pause Sampling or Clear Sampling Data

The [PAUSE/CLEAR] button has two functions. One is to pause sampling. Another is to clear the sampling data.

Press this button to pause data sampling when the sampling is executing. The <Chart> will also pause at the same time. Then if press this button one more time, sampling will be stopped and data will be cleared. Besides, the chart will also be cleared when in the <Chart> status.

4.11.3 < CURSOR >: The Display and Occultation of Cursor in <Chart>

The [CURSOR] button has two functions. One is to display or hide the <Cursor> in <Chart> status. Another is to choose <Cursor> again in other status.

When there is no cursor in <Chart>, this button can call out <Cursor>. Move <Cursor> through spinning the knob and then read the measurement value. If the <Cursor> has been paged out but not chosen (for example, when <Sensitivity> is highlighted and then the knob is only used to set parameters on <Sensitivity>), the <CURSOR> button can pick on <Cursor> again. Press the [CURSOR] again when the <Cursor> is already picked on, in this case, the <Cursor> will be hidden.

Spin the knob to move <Cursor>. If the <Cursor> exceeds the edge of <Chart>, the <Chart> will change to the next page. Also, <Cursor> can be positioned directly through <Curve Point> in <Disp More> menu. [CURSOR] makes sense when the data sampling is executing or pausing.

4.11.4 < ACTIVE CHART >: Choose <Chart> as the Active Area

The [ACTIVE CHART] is used to choose the <Top> or <Bottom> area of <Chart> as the current active area. <Cursor> only makes sense in active area. The chosen active area will be highlighted at the top-left corner of the <Chart>. The <Chart> in <Full> area is always active. Therefore, the [ACTIVE CHART] button makes no sense to <Full> area.

5. REMOTE PROGRAMMING

5.1 OE1022 Command Syntax

Computers use ASCII characters to communicate with OE1022. Commands must be in upper case. A command consists of a four-character command mnemonic, arguments if necessary, and a command terminator. The terminator must be a linefeed <lf> or carriage return <cr> on RS232

to USB. No command processing occurs until a command terminator is received. Commands may require one or more parameters. Multiple parameters are separated by commas (,).

Multiple commands may be sent on one command line by separating them with semicolons (;). The difference between sending several commands on the same line and sending several independent commands is that when a command line is parsed and executed, the entire line is executed before any other device action proceeds.

The OE1022 has a 256-character input buffer and processes commands in the order received. If the buffer fills up, the new commands will cover the oldest and processed commands.

OE1022 allows users to query the current value of internal parameters through commands. A query is formed by appending a question mark "?" to the command mnemonic and omitting the desired parameter(s) from the command. Values returned by the OE1022 are sent as a string of ASCII characters terminated by a corresponding terminator. If multiply queries are sent on one command line (separated by semicolons), the answers will be returned individually, each with a terminator.

Examples of Command Formats

FMOD1<cr>	Set reference source to internal
FREQ10E3<cr>	Set the internal reference frequency to 10kHz
OUTP?1<cr>	Queries the output value of CH1

5.2 Detailed Command List

The parameters in each command sequence specify the command. Multiple parameters are separated by commas. Parameters shown in {} are optional. Commands that may be queries have a question mark in parentheses (?) after the mnemonic. Do not send () or {} as part of the command.

The variables are defined as follows.

i, j, k, l, m, n, o, p, q, r, s, t, u	integers
x	real numbers
f	frequency

Note that all numeric variables can be expressed in integer, floating point or exponential formats (i.e., the number five can be 5, 5.0, or .5E1). Strings are sent as a sequence of ASCII characters.

5.2.1 Reference and Phase Commands

PHAS(?) {x} The PHAS command sets or queries the reference phase shift. The parameter x refers to the phase (real number, unit: °). The PHAS x command will set the current phase shift to x°.

The value of x is rounded to 0.01°. The phase can be programmed from -180°

to +180°. For example, send command "PHAS -179.0" and the phase shift will be set to -179°. The PHAS? command queries the phase shift.

FMOD(?) <i>{i}</i>	The FMOS command sets or queries the reference source. The parameter <i>i</i> selects external reference (<i>i</i> =0), internal reference (<i>i</i> =1) or internal sweep reference (<i>i</i> =2).
FREQ(?) <i>{f}</i>	The FREQ command sets or queries the reference signal. The FREQ? command will return the current reference frequency (internal or external).
RSLP(?) <i>{i}</i>	The RSLP command sets or queries the trigger way of reference signal when in external reference mode. The parameter <i>i</i> selects <TTL> rising edge (<i>i</i> =0) or <Sine> zero crossing (<i>i</i> =1). When the frequency is less than 1 Hz, the <TTL> reference must be used.
SWPT(?) <i>{i}</i>	The SWPT command sets or queries the mode of internal frequency sweep. The parameter <i>i</i> selects <Linear> (<i>i</i> =0) or <Log> (<i>i</i> =1).
SLLM(?) <i>{f}</i>	The SLLM command sets or queries the <Start> frequency in internal frequency sweep mode. The SLLM? command will return the start frequency. The range of <i>f</i> is 0-100kHz and the minimum resolution is 1mHz.
SULM(?) <i>{f}</i>	The SULM command sets or queries the <Stop> cutoff frequency in internal frequency sweep mode. The SULM? command will return the cutoff frequency. The range of <i>f</i> is 0-102kHz and the minimum resolution is 1mHz.
SSLL(?) <i>{f}</i>	The SSLL command sets or queries the step frequency in <Linear> internal frequency sweep mode. The SSLL? command will return the step frequency. The range of <i>f</i> is 0-102kHz and the minimum resolution is 1mHz.
SSLG(?) <i>{x}</i>	The SSLG command sets or queries the percentage in <Log> internal sweep mode. The SSLG? command will return the percentage in <Log> frequency sweep mode. The range of <i>x</i> is 0-100 and the minimum resolution is 0.001. <i>x</i> =50 means that the percentage is 50%.
STLM(?) <i>{i}</i>	The STLM command sets or queries the step time in internal frequency sweep mode. The STLM? command will return the step time of internal sweep mode. The range of <i>i</i> is 1ms-100,000ms and the minimum resolution is 1ms.
SWRM(?) <i>{i}</i>	The SWRM command sets or queries the running mode in internal frequency sweep mode. The parameter <i>i</i> selects <STOP> (<i>i</i> =0) , <Single> (<i>i</i> =1) or <Loop> (<i>i</i> =2).
HARM(?) <i>{i,j}</i>	The HARM command sets or queries harmonic detection. The parameter <i>i</i> selects harmonic 1 (<i>i</i> =1) or harmonic 2 (<i>i</i> =2) and is required. The parameter <i>j</i> is

an integer from 1 to 32767. The HARM i,j command will set the OE1022 to detect at the j^{th} harmonic of reference frequency. The value of j is limited by $j \cdot f \leq 102\text{kHz}$. If the value of j requires a detection frequency larger than 102kHz, then j will be set to the maximum value that meets this condition.

- SLVL(?) $\{x\}$ The SLVL command sets or queries the amplitude of the output synchronous sine wave. The parameter x determines the amplitude of voltage (real number, unit: V). The range of x is $0.000\text{Vrms} \leq x \leq 5.000\text{Vrms}$ and x is rounded to 0.001Vrms.
- SWVT(?) $\{i\}$ The SWVT command sets or queries the output type of <Sine Output>. The parameter i selects fixed amplitude output (i=0), linear amplitude sweeping output (i=1) or logarithm amplitude sweeping output (i=2).
- SVLL(?) $\{x\}$ The SVLL command sets or queries <Start> amplitude in <Sine Output> sweep mode. The SVLL? command will return the start amplitude of sweeping amplitude. The range of x is $0.001\text{Vrms} \leq x \leq 5.000\text{Vrms}$ and the minimum resolution is 0.001Vrms.
- SVUL(?) $\{x\}$ The SVUL command sets or queries <Stop> cutoff amplitude in <Sine Output> sweep mode. The SVUL? command will return the cutoff amplitude of sweeping amplitude. The range of x is $0.000\text{Vrms} \leq x \leq 5.000\text{Vrms}$ and the minimum resolution is 0.001Vrms.
- SVSL(?) $\{x\}$ The SVSL command sets or queries <Step> amplitude in <Linear> <Sine Output> sweep mode. The SVSL? command will return the step amplitude of linear sweeping amplitude mode. The range of x is $0.000\text{Vrms} \leq x \leq 5.000\text{Vrms}$ and the minimum resolution is 0.001Vrms.
- SVSG(?) $\{x\}$ The SVSG command sets or queries the percentage in <Log> <Sine Output> sweep mode. The SVSG? command will return the percentage in <Log> sweep amplitude mode. The range of x is 0-100 and the minimum resolution is 0.001. x=50 means that the percentage is 50%.
- SVTM(?) $\{x\}$ The SVTM command sets or queries step <Time> in <Sine Output> sweep mode. The SVTM? command will return the step <Time> of logarithm amplitude sweeping. The range of x is 1ms-100,000ms and the minimum resolution is 1ms.
- SVRM(?) $\{i\}$ The SVRM command sets and queries the executing mode in <Sine Output> sweep mode. The parameter i selects <Stop> (i=0), <Single> (i=1) or <Loop> (i=2).

5.2.2 Equation Commands

EQCD(?)i{j,k,l} The EQCD i command sets or queries the parameter value of A, B and C in four <Equation>. The parameter i selects Equation1(i=1), Equation2(i=2), Equation3(i=3) or Equation4(i=4).

The parameter j, k, l are corresponding to A, B, C in <Equation> and selects the numbers below.

j, k, l	Parameter
0	R
1	X
2	Y
3	θ
4	Rh1
5	Xh1
6	Yh1
7	θ h1
8	Rh2
9	Xh2
10	Yh2
11	θ h2
12	Noise
13	A1
14	A2
15	A3
16	A4
17	Freq
18	C1
19	C2

For example, send command “EQCD 2,0,18,17” and then the Equation 2 will be set as: $E2=R \cdot C1 / \text{Freq}$.

The EQCD? i command queries the configuration parameters of Equation i. Values are returned as the serial number corresponding to A, B, C with the values separated by commas. For example, send command “EQCD? 2” and return string “0,18 17”. In this case, for the Equation2, A is the value of <R>, B is the value of <C1>, C is the value of <Freq>.

EQCS(?)i{x} The EQCS command sets or queries two coefficients <C1>, <C2>. The parameter i selects to set <C1> (i=1) or <C2> (i=2) and is required when sending this command.

The parameter is used to set the value of coefficients and the range is $-10.000 \leq x \leq 10.000$.

For example, send command “EQCS 2,5.00” and this will set the value of <C2> to 5.00.

5.2.3 Input and Filter Commands

- ISRC(?)*{i}* The ISRC command sets or queries the input configuration. The parameter *i* selects A (single input mode) (*i*=0), A-B (differential voltage input mode) (*i*=1), I (1 MΩ) (current input and the expand is $10^6V/A$) (*i*=2) or I (100 MΩ) (current input and the expand is $10^8V/A$) (*i*=3).
- IGND(?)*{i}* The IGND command sets or queries the input shield grounding. The parameter *i* selects Float (*i*=0) when the input ground is connected to the instrument ground with a 10 kΩ resistor or Ground (*i*=1) when the input ground is connected to the instrument ground with a 10 Ω resistor.
- ICPL(?)*{i}* The ICPL command sets and queries the input coupling. The parameter *i* selects AC (*i*=0) or DC (*i*=1).
- ILIN(?)*{i}* The ILIN command sets and queries the notch filter status. The parameter *i* selects to close notch filters (*i*=0), open the 50Hz notch filter (*i*=1), open the 50Hz and 100Hz notch filter at the same time (*i*=2) or open the 100Hz notch filter (*i*=3).

5.2.4 Sensitivity and Time Constants Commands

SENS(?)*{i}* The SENS command sets or queries the sensitivity. The parameter *i* is used to select a different range.

<i>i</i> sensitivity	<i>i</i> sensitivity
1: 1 nV/fA	15: 50 uV/pA
2: 2 nV/fA	16: 100 uV/pA
3: 5 nV/fA	17: 200 uV/pA
4: 10 nV/fA	18: 500 uV/pA

5: 20 nV/fA	19: 1 mV/nA
6: 50 nV/fA	20: 2 mV/nA
7: 100 nV/fA	21: 5 mV/nA
8: 200 nV/fA	22: 10 mV/nA
9: 500 nV/fA	23: 20 mV/nA
10: 1 uV/pA	24: 50 mV/nA
11: 2 uV/pA	25: 100 mV/nA
12: 5 uV/pA	26: 200 mV/nA
13: 10 uV/pA	27: 500 mV/nA
14: 20 uV/pA	28: 1 V/uA

RMOD(?)*{i}* The RMOD command sets or queries the mode of dynamic reserve. The parameter *i* selects <Low Noise> (*i*=0), <Normal> (*i*=1) or <High Reserve> (*i*=2).

OFLT(?)*{i}* The OFLT command sets or queries the time constant of filters. The parameter *i* selects a time constant below.

<i>i</i> time constant	<i>i</i> time constant
1: 10 us	10: 300 ms
2: 30 us	11: 1 s
3: 100 us	12: 3 s
4: 300 us	13: 10 s
5: 1 ms	14: 30 s
6: 3 ms	15: 100 s
7: 10 ms	16: 300 s
8: 30 ms	17: 1000 s
9: 100 ms	18: 3000 s

OFSL(?)*{i}* The OFSL command sets or queries the low pass filter slope. The parameter *i* selects <6dB/oct> (*i*=0), <12dB/oct> (*i*=1), <18dB/oct> (*i*=2) or <24dB/oct> (*i*=3).

SYNC(?)*{i}* The SYNC command sets or queries the status of synchronous filter. The parameter *i* selects Off (*i*=0) or On (*i*=1). The synchronous filtering is turned on only when the reference frequency is less than 200 Hz.

5.2.5 Display and Output Commands

FPOP(?)*{i,j}* The FPOP *i* command sets and queries the output channel on the front panel of OE1022. The parameter *i* must be set when sending this command. The parameter *i* selects CH1 (*i*=1) or CH2 (*i*=2) as the output channel. The parameter *j* is used to select the type of output source. More details are as follow.

CH1(i=1)		CH2(i=2)	
j	Input Type	j	Output Type
0	R	0	R
1	X	1	X
2	Y	2	Y
3	θ	3	θ
4	Rh1	4	Rh1
5	Xh1	5	Xh1
6	Yh1	6	Yh1
7	θ h1	7	θ h1
8	Rh2	8	Rh2
9	Xh2	9	Xh2
10	Yh2	10	Yh2
11	θ h2	11	θ h2
12	Noise	12	Noise
13	E1	13	E1
14	E2	14	E2
15	E3	15	E3
16	E4	16	E4

OEXP(?)i{x,j} The OEXP i command sets or queries the output offsets and expands. The parameter i must be set when sending this command. The parameter i selects the type of parameters below.

i	Parameter
0	R
1	X
2	Y
3	Rh1
4	Xh1
5	Yh1
6	Rh2
7	Xh2
8	Yh2
9	Noise

The parameter x is used to set the offset and the range is $-100.00 \leq x \leq 100.00$. The parameter j is used to set expand and the range is $1 \leq x \leq 256$. For example, send command "OEXP 2,50.00,2" and then the offset of parameter <Y> is 50%; the output expand is 2. Parameter x and j are required to send.

The OEXP? i command queries the offset and expand of the corresponding parameter of i. The returned string contains both the offset and expand separated by a comma. For example, if the OEXP? 2 command returns "50.00,1" then the offset of Y is 50.00% and the expand of Y is 10.

- OAUX (?)i{x}** The OAUX? Command sets or queries the AUX_DAC output values. The parameter i must be set when sending this command. The parameter i is used to select a DAC channel and x is used to set the voltage of DAC. The voltage range is $-10.000V \leq X \leq 10.000V$. For example, send command "OAUX 2,5.00" and then the channel voltage of <DAC2> is set to 5.00V.
- SPED(?)i** The SPED command sets or queries the executing mode of <Channel Output>. The parameter i selects <Slow> (i=0) or <Fast> (i=1).
In the <Fast> mode, the output can only choose <R>, <X> and <Y>. If in <Slow> mode and the current choice is not <R>, <X> or <Y>, then when switching to <Fast> mode, the output will choose <R> automatically.

5.2.6 Save and Read Settings Commands

- SSET i** The SSET i command saves the current setup in setting buffer i ($1 \leq i \leq 4$). The parameter i selects S1 (i=1), S2 (i=2), S3 (i=3) or S4 (i=4). The setting buffers are retained when the power is off.
- RSET i** The RSET i command recalls the saved setup information from buffer i ($1 \leq i \leq 4$). After executed the RSET i command, the internal parameters will be set as corresponding parameter in the setting buffer i. The parameter i selects S1 (i=1), S2 (i=2), S3 (i=3), S4 (i=4) and Default (i=5).

5.2.7 Auto Set Commands

- AGAN** The AGAN command performs the Auto Gain function. It is the same as pressing the [Auto Gain] key. Auto Gain may take some time if the time constant is long.
- ARSV** The ARSV command performs the Auto Reserve function. It is the same as pressing the [Auto Reserve] key. Auto Reserve may take some time.
- APHS** The APHS command performs the Auto Phase function. It is the same as pressing the [Auto Phase] key.
The outputs will take some time to reach their new values. Do not send a new APHS command without waiting the appropriate amount time. If the phase is unstable, then APHS will do nothing.
Use PHAS? Command to query the new value of the phase shift and see if APHS changed the phase shift.
- ASCL** The ASCL command performs the Auto Scale function. It is the same as pressing the [Auto Scale] key.

5.2.8 Data Store Commands

SRAT(?)*{i}* The SRAT command sets or queries the step time of data sampling. SRAT? command will return the value of step time in sampling. The setting range of i is 1ms-100,000ms. The minimum resolution is 1ms.

SLEN(?)*{i}* The SLEN? command sets or queries the length of data sampling. The maximum length is 16384.

SSLE(?)*i**{,j}* The SSLE *i* command sets or queries the chosen parameters in four buffers. The parameter *i* must be set when sending this command. The parameter *i* selects <Buffer 1> (*i*=1), <Buffer 2> (*i*=2), <Buffer 3> (*i*=3) or <Buffer 4> (*i*=4). The parameter *j* means the recorded measurement value in buffers. The parameter *j* selects the parameters as the following.

j	Parameter
0	R
1	X
2	Y
3	θ
4	Rh1
5	Xh1
6	Yh1
7	θ h1
8	Rh2
9	Xh2
10	Yh2
11	θ h2
12	Noise
13	A1
14	A2
15	A3
16	A4
17	E1
18	E2
19	E3
20	E4
21	Freq

STRG(?)*{i}* The STRG? command sets or queries the trigger way of data sampling. The parameter *i* selects inner trigger mode <INT> (*i*=0) or outer trigger mode <EXT> (*i*=1).

SPRM(?)*{i}* The SPRM? command sets or queries the mode of data sampling. The parameter *i* selects <Single> mode (*i*=0) or <Loop> mode (*i*=1).

- STRD The STRD command starts or continues data sampling.
- PAUS The PAUS command pauses data sampling.
- REST The REST command resets the data buffers. This command will empty the four data buffers, including Buffer1 ~ Buffer4.

5.2.9 Data Read Commands

- OUTP? i The OUTP? i command is used to read a single parameter value. The parameter i selects the parameters as the following.

j	Parameter
1	X
2	Y
3	R
4	θ
5	Xh1
6	Yh1
7	Rh1
8	θ h1
9	Xh2
10	Yh2
11	Rh2
12	θ h2
13	Noise
14	A1
15	A2
16	A3
17	A4
18	Freq

Values are returned as ASCII floating point numbers with units of Volts, degrees or Hz. This command is a query only command.

- SNAP?i,j,{k,l,m,n,o,p,q,r,s,t,u} The SNAP? command records the values of no more than 13 parameters at a single instant.
- For example, SNAP? is a way to query values of <X>, <Y>, <R>, < θ > and <F> which are taken at the same time. This is important when the time constant is very short. Using the OUTP? or OUTF? commands will result in time delays, which may be greater than the time constant, between reading two different parameters.

The SNAP? command requires at least two parameters and at most thirteen parameters. The parameters i, j, k, l, m, n, o, p, q, r, s, t, u select the parameters below.

i,j,k,l,m,n,o ,p,q,r,s,t,u	Parameter
1	X
2	Y
3	R
4	θ
5	Frequency
6	Xh1
7	Yh1
8	Rh1
9	θ h1
10	Xh2
11	Yh2
12	Rh2
13	θ h2
14	Noise
15	A1
16	A2
17	A3
18	A4
19	E1
20	E2
21	E3
22	E4

The requested values are returned in a single string with the values separated by commas and in the order in which they are requested. For example, the SNAP?1,2,5,4 will return the values of <X>, <Y>, <Frequency> and < θ >. These values will be returned in a single string such as "0.951359,0.0253297,1000.00,1.234". The first value is <X>, the second is <Y>, the third is <Frequency> and the fourth is < θ >.

The SNAP? command is only used to record various parameters simultaneously.

SPTS?

The SPTS? command queries the number of points stored in the buffer. This command can be sent at any time. If the data buffer is reset, then 0 is returned. This command is a query only command.

TRCA?i,j,k

The TRCA? command queries the data (Buffer1~Buffer 4) in the channel i Buffer.

The values are returned as ASCII floating point numbers with the units of the

trace. Multiple points are separated by commas (,) and the final point is followed by a terminator. For example, the response of two points might be “-1.234567e-009, +7.654321e-009”.

The parameter *i* selects the display buffer (*i*=1,2,3,4) and is required to send with this command. Points are read from the buffer starting at bin *j* (*j*≥0); A total of *k* bins are read (*k*≥1); To read a single point, set *k*=1. Both *j* and *k* are required. If *j*+*k* exceeds the number of stored points (as returned by the SPTS? query), then an error occurs. So, the value of *j*+*k* should be no more than 16384 which is the maximum number of data stored in the buffer.

5.2.10 Reset and IDN Commands

- RST** The RST command is used to reset OE1022 to its default configurations. All internal status and parameters are set to their default conditions and values. Data stored in the buffers will be lost.
- IDN?** The IDN? query returns the OE1022's device identification string. This string is in the format “SSL LIA-OE1022, SNXXXXXX, VerXXX”. In this example, the model name is OE1022; the serial number is SN0001; the firmware version is Ver1.00.

6. COMPUTER OPERATION

6.1 Install Software

The required software is provided with the CD disk as below in Fig 48.

Name	Date modified	Type
OE1022_Console Drivers	8/14/2017 3:50 PM	File folder
OE1022_Console_EN	8/14/2017 3:49 PM	File folder
Uart Assistant	8/14/2017 3:50 PM	File folder
Uart Driver	8/14/2017 3:57 PM	File folder
OE1022_introduction_EN.pdf	8/2/2016 2:53 PM	Foxit Reader PDF ...
OE1022_Uer_Manual.pdf	8/12/2016 10:08 AM	Foxit Reader PDF ...
readme.txt	7/13/2016 8:53 AM	Text Document

Fig.48 Software files.

1. Install the UART to USB Driver

Double-click “FT232_drive.exe” in Fig 49 in the fourth file “Uart Driver” in Fig.48.

Name	Date modified	Type
Inf installation file	8/14/2017 3:50 PM	File folder
FT232_drive.exe	3/8/2017 2:36 PM	Application
readme.txt	9/22/2014 3:01 PM	Text Document

Fig.49 “Uart Driver” files

Double-click the file “FT232_drive.exe” in Fig 49 and then you can see the Fig 50, which shows the installation is running.

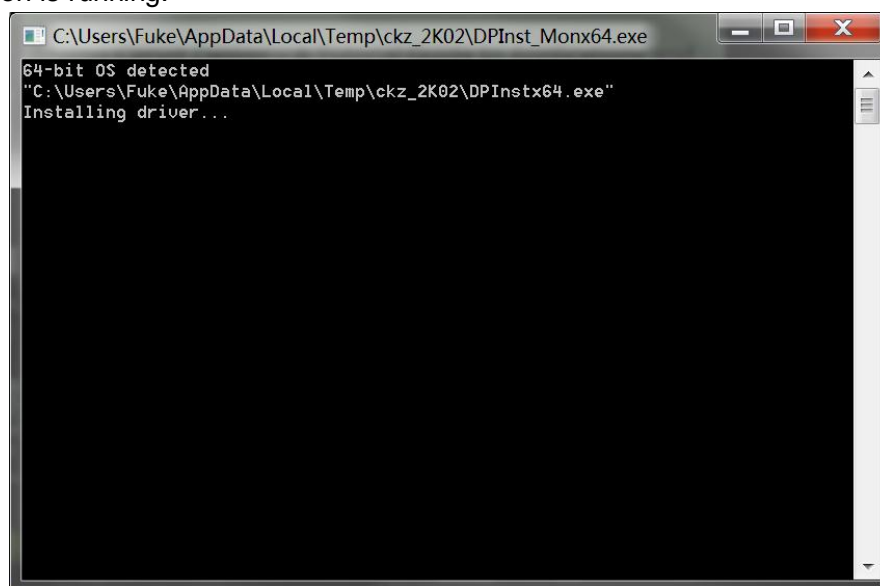

Fig.50 FT232 Driver Installing Interface

After the installation is finished, you will see the Fig 51. Then press “Enter” key to finish it.

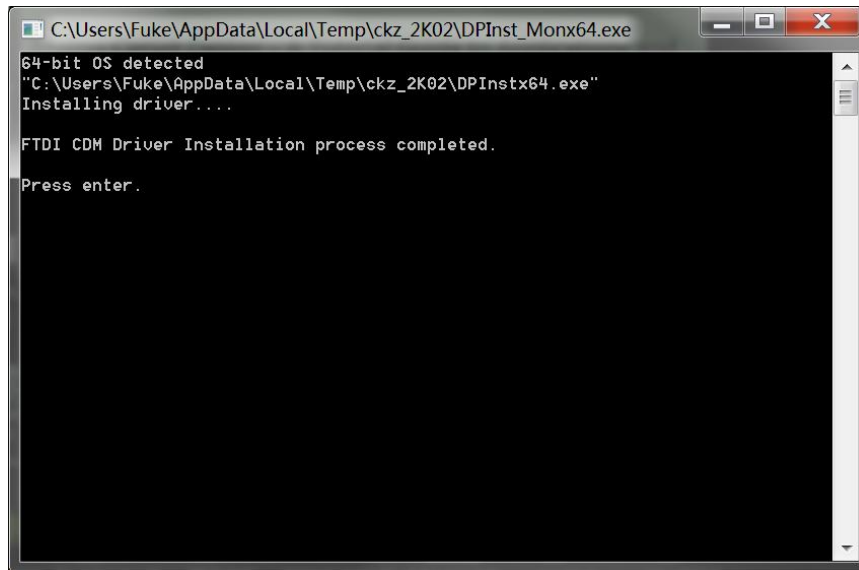

Fig.51 FT232 Driver is installed successfully.

Now, use a USB cable to connect the PC and OE1022. If the driver is OK, they will be linked automatically.

Note that if the PC is online, the PC will search the proper driver online when you connect the PC and OE1022. And the installation will run automatically.

If you have already installed the Serial to USB driver, skip this step.

If the installation fails, open “readme.txt” in file “Uart Driver” and use file “inf” to install.

2. Install NI LabView 2011 or Higher Version and the VISA Driver

- 1) You need to open the first file “OE1022_Console Drivers” in Fig.48 and start to install just as shown in Fig 52.
- 2) Double click the file “setup.exe” and start to install the VISA driver of OE1022. Generally, just install it according to the default configuration.
- 3) Note that after the installation is finished, restart the PC to complete the configuration.

Name	Date modified	Type
bin	8/14/2017 3:49 PM	File folder
license	8/14/2017 3:49 PM	File folder
supportfiles	8/14/2017 3:50 PM	File folder
nidist.id	9/22/2014 4:31 PM	ID File
setup.exe	5/6/2013 5:01 PM	Application
setup.ini	9/22/2014 4:31 PM	Configuration sett...

Fig.52 “OE1022_Console Drivers” File

3. Install OE1022_Console_EN.

- 1) Open the second file “OE1022_Console_EN” in Fig 48.
This file contains Chinese and English application software and they both can operate in Windows 7/XP.
- 2) Double click the file “OE1022_Console_EN.exe” in Fig 53 red box.
If the installation is right, and then you will see the Fig 54.
- 3) Now you can configure the OE1022 parameters in PC.

Name	Date modified	Type
OE1022_Console_EN.aliases	8/16/2017 9:10 AM	ALIASES File
SSI OE1022_Console_EN.exe	8/16/2017 9:10 AM	Application
OE1022_Console_EN.ini	8/16/2017 9:10 AM	Configuration sett...
OE1022_Console_EN.tlb	8/16/2017 9:10 AM	TLB File
OE1022ConsoleEN.log	8/16/2017 9:10 AM	Text Document

Fig.53 “OE1022_Console_EN” Files

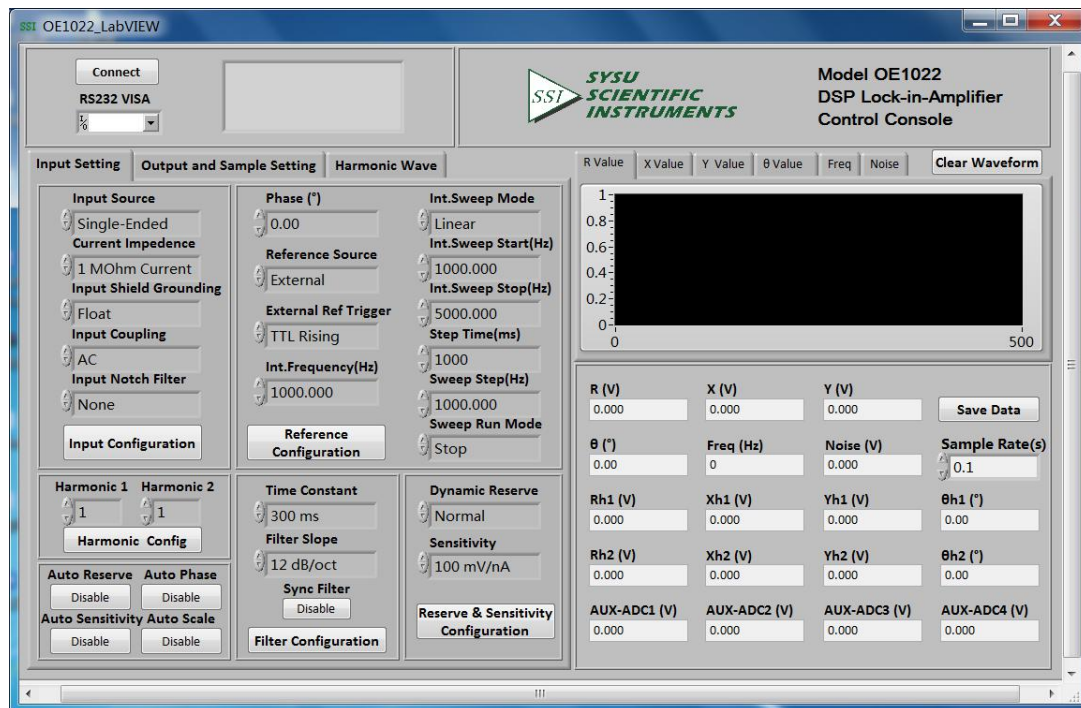
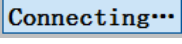

Fig.54 OE1022 Software Interface

6.2 How to Use the Software

6.2.1 Begin to Run

In Fig. 55, if you see [Connecting] as (left), it means the program is running. If you see [Connect] as (right), it shows the program is broke down.

You can click the button  to switch between these two statuses.

Note that before the program runs, the Baud rate of the OE1022 should set to 921600bd.

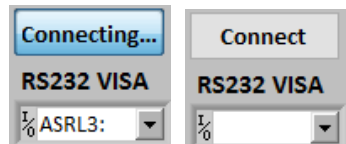

Fig.55(left) Program is running (right) Program stops.

6.2.2 Connection

This part shows you how to connect the PC and the OE1022.

As is shown in Fig 56, click the button .



Fig.56 Current Connection Status

The program begins to run and search for the proper COM automatically. If the connection succeeds, you will see the version information in Fig.57.

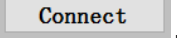
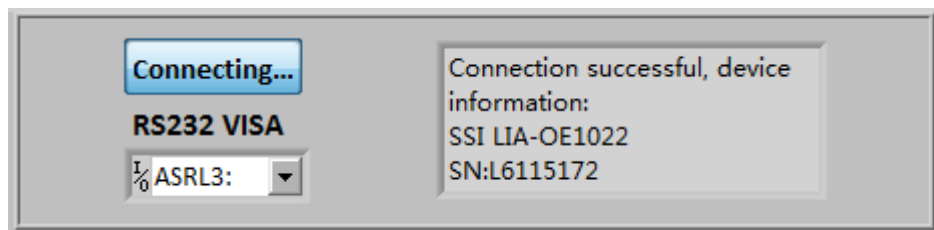

Fig.57 Connection Succeeds

Wait for a few seconds. If the interface pops up a prompt box like Fig.58, it means that the connection between PC and OE1022 fails.

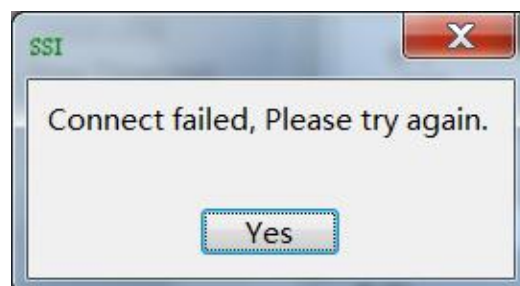

Fig.58 Connection fails and USB device search fails.

Click the button [YES] to check the status of the connection. Now the right of the status window

will display the wrong information, as is shown in Fig.59.

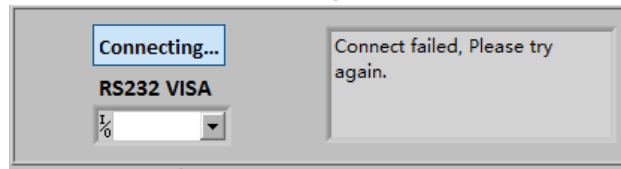

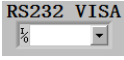
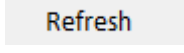

Fig.59 Connection fails and try re-connection

Two solutions to re-connect:

The first solution:

- 1) Click  at the right side of the option .
- 2) Click  at the drop-down list.
- 3) Choose the right COM number. If the COM is right, the connection will success after few seconds.



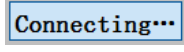
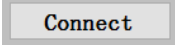
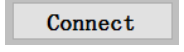

Note that when the PC is connected to OE1022 with USB, you can go to “Device Manager” to search “COM and LPT”. In this case, you can know which COM is used to connect currently.

If the COM is right, wait for a few seconds and the connection status will refresh to Fig.57

The second solution:

- 1) Click . Wait until it becomes .
- 2) Click  again.
- 3) Repeat the operations 1 and 2 until the connection is successful.

After connection successes, as is shown in Fig.60, the data in red box will be empty and it will restart a new display. It displays the value of R in default.

You can choose      to display the value of X, Y, θ , frequency and noise at top of the red box. The software interface will display the parameters of the OE1022 current configuration. You can set other parameters shown on the GUI.

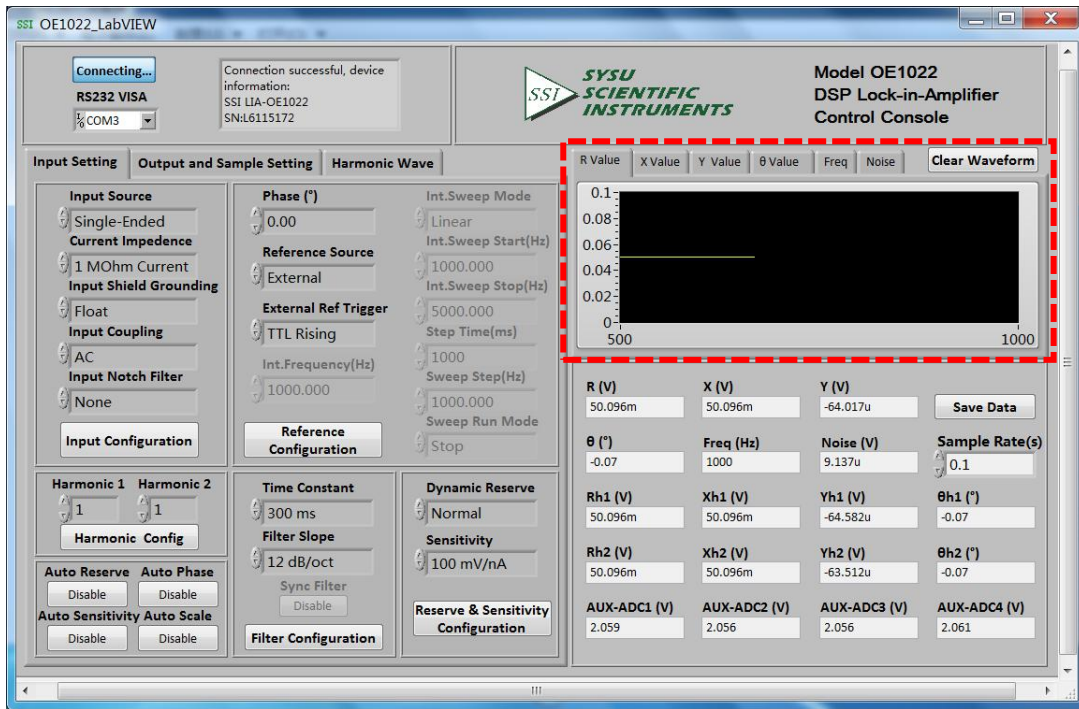

Fig.60 OE1022 Software Connection Succeeds

6.2.3 Input Configuration

The program configuration area of input signal is as shown in the red box in Fig.61. The details of the configuration are listed on Table 3.

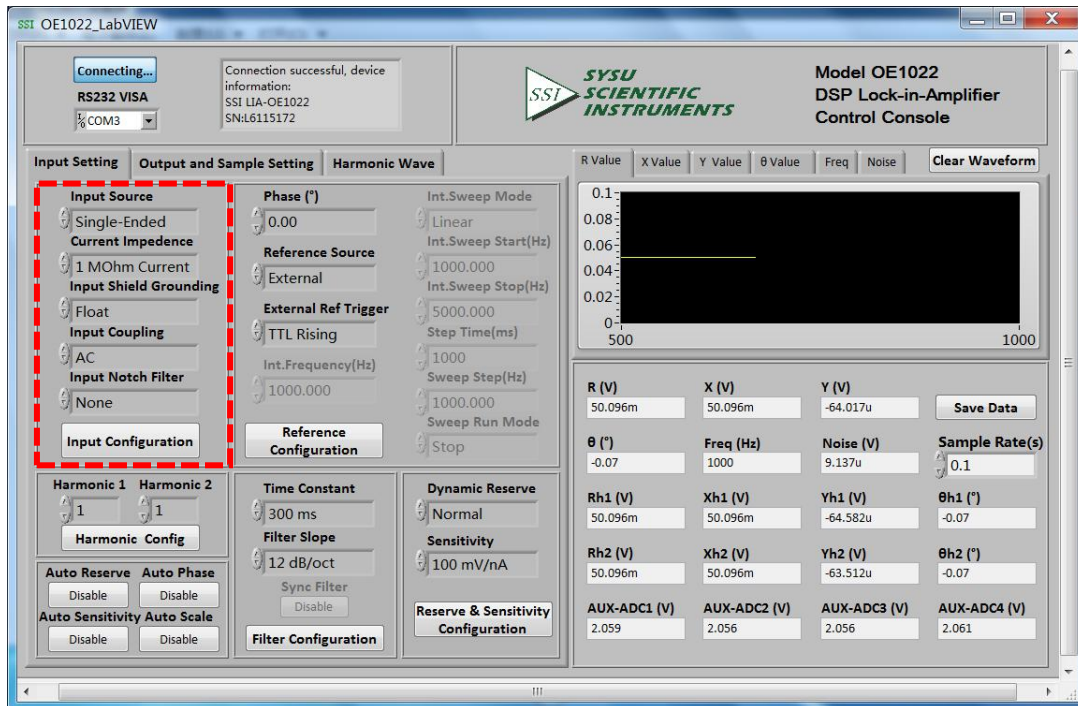

Fig.61 The Configuration area of Input Signal

Table 3. Input Configuration	
Input Source	Single-Ended Voltage
	Differential Voltage
	Current
Current Impedance	1M Ω Current Gain (when the input signal is small, the gain is 10E6 V/A)
	100M Ω Current Gain (when the input signal is small, the gain is 10E8 V/A)
Input Shield Grounding	Float (the input connector ground and the instrument ground are isolated by a 10k Ω resistor.)
	Ground (t the input connector ground and the instrument ground are isolated by a 10 Ω resistor.)
Input Coupling	AC coupling
	DC coupling
Input Notch Filter	None (Don't open the notch filter)
	Line Notch (Open the 50Hz notch filter to suppress the frequency interference)
	Both Notch Filters (Open the 50Hz and 100Hz notch filters to suppress the frequency and frequency second harmonic interference).
	2x Line Notch (Open the 100Hz notch filters to suppress the frequency interference).

Note that:

1. After finishing all the settings, click **Input Configuration** to finish the configuration for input signal. All settings can be changed at the same time and you just need to click this button once.
2. After changing the settings, you need to click **Input Configuration** to finish this configuration. Otherwise the settings are void.

6.2.4 Reference and Frequency Sweep Configuration

Reference Signal Configuration:

The configuration area of reference signal is shown in the red box in Fig.62. The details of configuration are shown in Table 4.

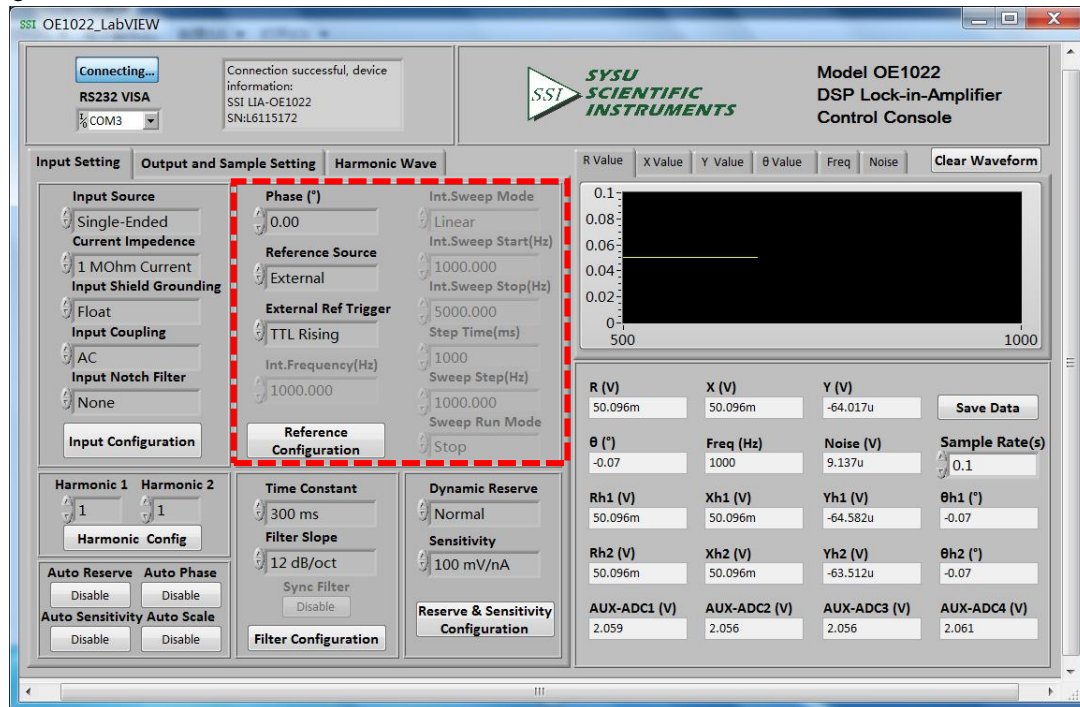

Fig.62 The Configuration Area of Reference Signal

PHASE	Setting the phase shift of two orthogonal reference signals for PSD algorithm. The range is -180° to $+180^{\circ}$ and the resolution is 0.01°
Reference Source	External Internal
External Ref Trigger	TTL Rising Edge Sine Zero Crossing
Int. Frequency	Manually, 1mHz to 102kHz by one-step of 1mHz at least.

Note that:

- After finishing all the settings, click the button **Reference Configuration** to finish the configuration for input signal. All settings can be changed at the same time and you just need to click the button once.
- After changing the settings, you need to click **Reference Configuration** to finish this configuration. Otherwise, the settings are void.

Frequency Sweep Configuration:

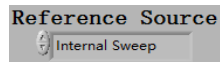

Choose the button to configure internal frequency sweep as is shown in Fig 63.

The details of configuration are shown in Table 5.

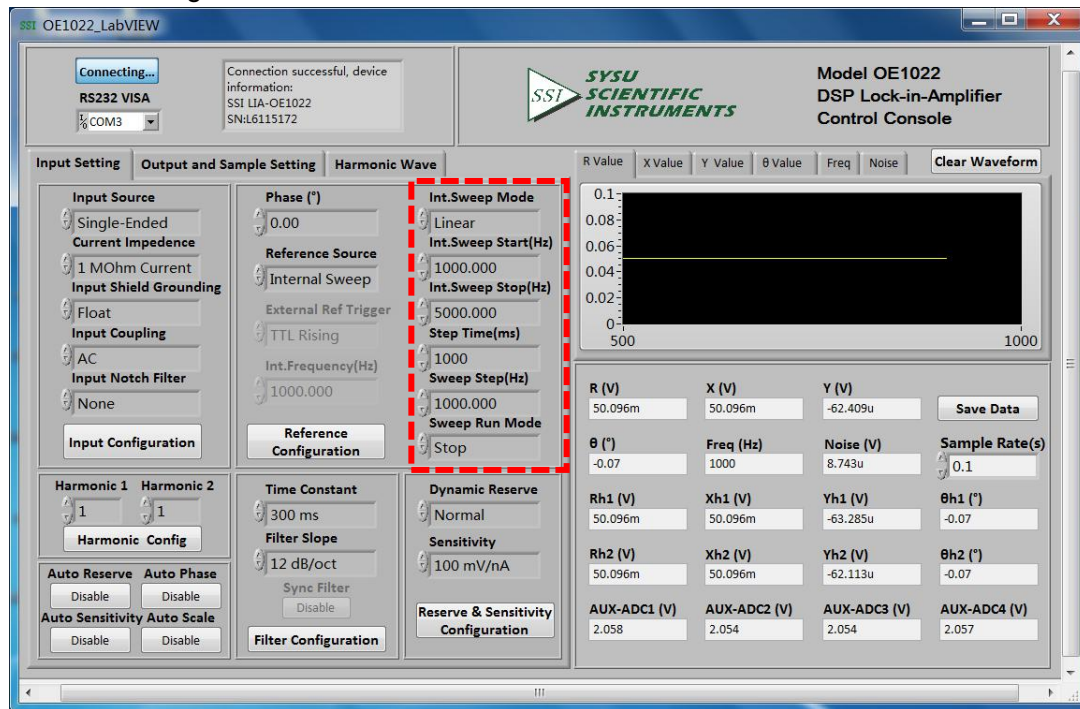
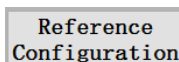

Fig.63 The Configuration Area of Internal Frequency Sweep

Int. Sweep Type	Linear
	Log
Int. Sweep Start (Hz)	Setting the start frequency of sweep manually. The frequency range is from 1mHz to 102kHz and the minimum resolution is 1mHz.
Int. Sweep Stop (Hz)	Setting the stop frequency of sweep manually. The frequency range is from 1mHz to 102kHz and the minimum resolution is 1Hz.
Linear Step Time (ms)	Setting the step time for every sweep manually. The step range is from 1ms to 100s and the minimum resolution is 1ms.
Int. Sweep Step (Hz)	Setting the step frequency for every sweep manually. the step range is from 1Hz to 102kHz and the minimum resolution is 1Hz.
Int. Sweep Run Mode	Single
	Loop
	Stop

Note that:



After finishing all the settings, click the button to finish the configuration for input signal. All settings can be changed at the same time and you just need to click this button once.

6.2.5 Dynamic Reserve and Sensitivity Configuration

The configuration area of Dynamic Reserve and Sensitivity is in the red box in Fig.64. The details of configuration are listed on the Table 6.

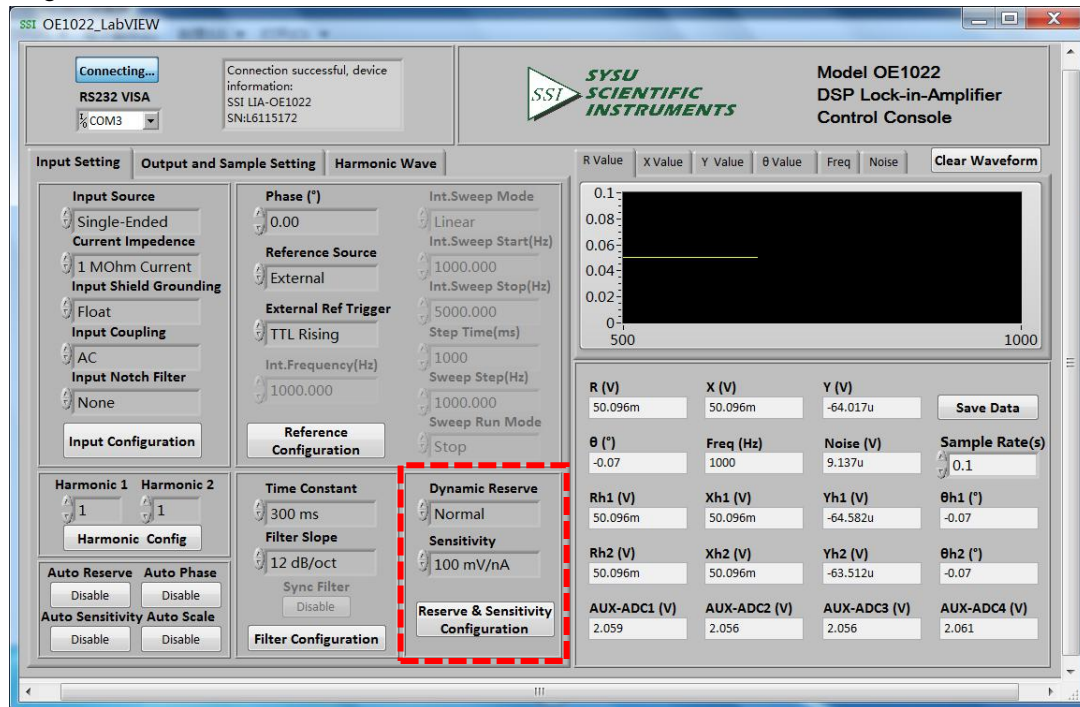
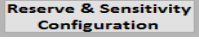
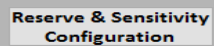

Fig.64 The Configuration Area of Dynamic Reserve and Sensitivity

Table 6. Dynamic Reserve and Sensitivity Configuration				
Dynamic Reserve	Low Noise			
	Normal			
	High Reserve			
Sensitivity	1nV/fA	200nV/fA	50 μ V/pA	10mV/nA
	2nV/fA	500nV/fA	100 μ V/pA	20mV/nA
	5nV/fA	1 μ V/pA	200 μ V/pA	50mV/nA
	10nV/fA	2 μ V/pA	500 μ V/pA	100mV/nA
	20nV/fA	5 μ V/pA	1mV/nA	200mV/nA
	50nV/fA	10 μ V/pA	2mV/nA	500mV/nA
	100nV/fA	20 μ V/pA	5mV/nA	1V/ μ A

Note that:

1. After finishing all the settings, click the button  to finish the configuration for input signal. All settings can be changed at the same time and you just need to click this button once.

2. Once you change the settings, you need to click  to finish this configuration. Otherwise, the settings are void.

6.2.6 Harmonic Configuration

The harmonic configuration is in the red box in the Fig.65. The details of configuration are shown in Table 7.

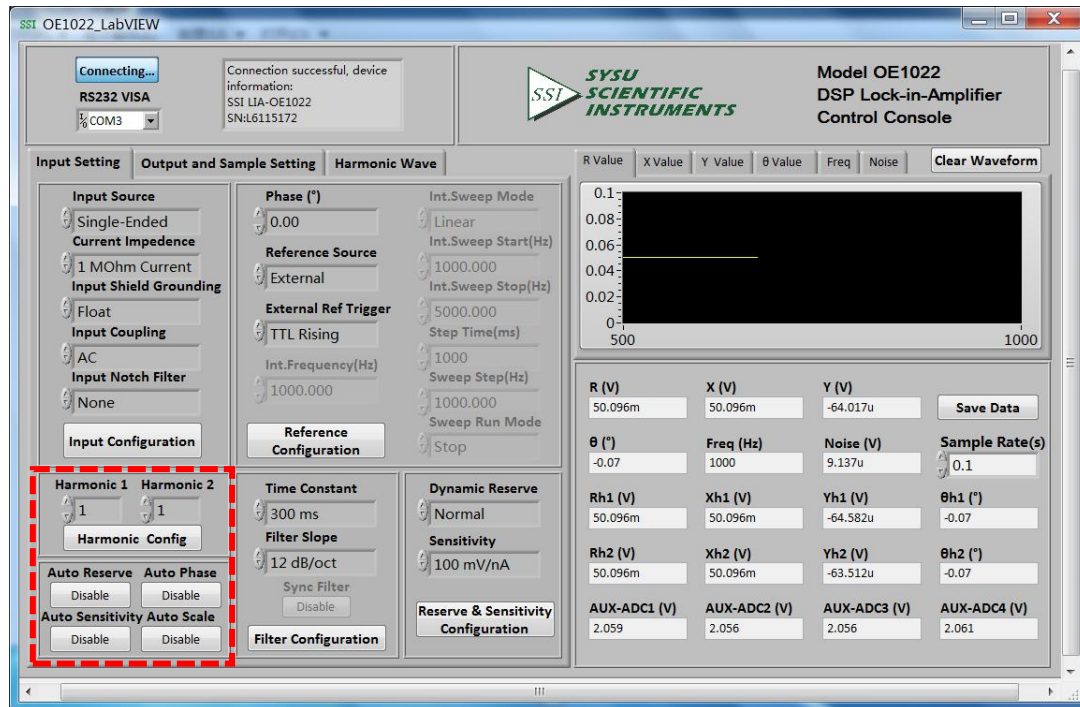

Fig.65 The Configuration Area of Harmonic Configuration

Setting	Configuration Options
Harmonic 1	Manually, the range is 1-32767.
Harmonic 2	Manually, the range is 1-32767.
Auto Sensitivity	Disable / Enable
Auto Reserve	Disable / Enable
Auto Phase	Disable / Enable
Auto Scale	Disable / Enable

Note that:

- After choosing all the settings, click the button **Harmonic Config** to finish the configuration; all settings can be changed at the same time and you just need to click this button once.
- The configurations of “Auto Sensitivity,” “Auto Reserve,” “Auto Phase” and “Auto Scale” are relatively independent. Click the corresponding **Disable** not the button **Reserve & Sensitivity Configuration** to close or open the auto function. The button will switch to be processing after click the button **Disable**. This means the OE1022 is executing the auto function. After finishing this process, this button will reset to the start status **Disable**. And then the “dynamic reserve” and “sensitivity” will refresh to the value that OE1022 returns.

6.2.7 Filter Configuration

The filter configuration is in the red box of the Fig.66. The details of configuration are listed on the Table 8.

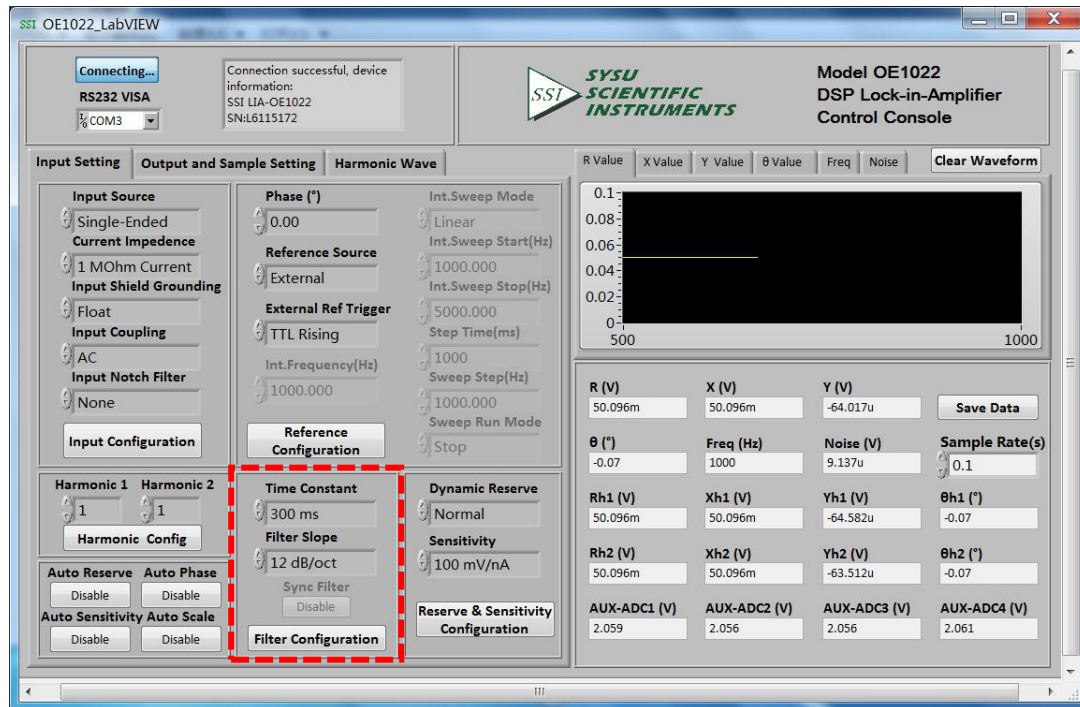

Fig.66 The Configuration Area of Filter

	10 μ s	3ms	1s	300s
Time Constant	30 μ s	10ms	3s	1000s
	100 μ s	30ms	10s	3000s
	300 μ s	100ms	30s	
	1ms	300ms	100s	
	Filter Slope	6dB/oct	12dB/oct	18dB/oct
SYNC Filter	Disable			
	Enable			

Note that:

1. After choosing all the settings, click the button **Filter Configuration** to finish the configuration. All settings can be changed at the same time and you just need to click this button once.
2. After changing the settings, you need to click this button to finish this configuration. Otherwise the settings are void.
3. The configurations of “Sync Filter” is relatively independent. Click the corresponding **Disable** not the button **Filter Configuration** to close or open the auto function. The button will switch to

Sync Filter **Disable** when click the button **Disable**. This means the OE1022 is executing the auto function.

If you need to close the sync filter, click this button again and it will reset to the start status **Disable**. This means you have closed the sync filter successfully.

6.2.8 Output Configuration

The output configuration is in the red box of the Fig.67. The details of the configuration are listed in the Table 9.

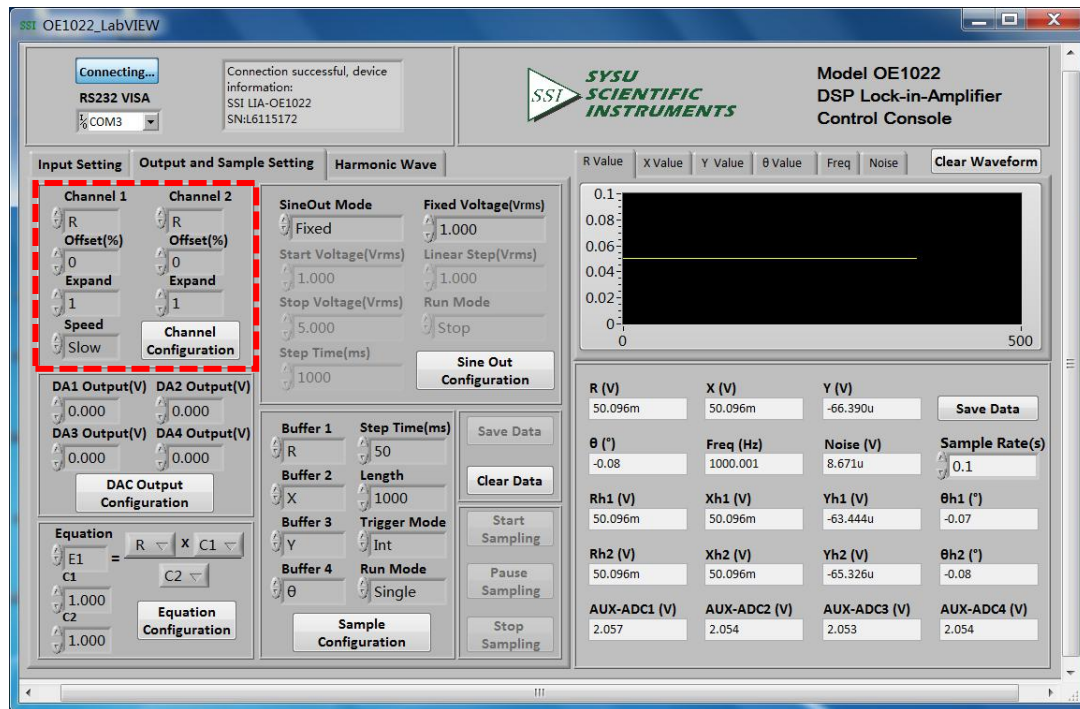
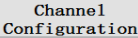
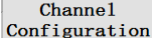

Fig.67 The Configuration Area of Output Channel

Channel 1	Choose CH1 to output the required values. The value types contain the X/Y/R/ θ value of signal and signal harmonic, the noise value and the E1/E2/E3/E4 value.
Channel 2	Choose CH2 to output the required values. The value types contain the X/Y/R/ θ value of signal and signal harmonic, the noise value and the E1/E2/E3/E4 value.
Offset (%)	The range is -100% to +100%, the minimal step is 0.01%, 0.00% in default. It can only set the R/X/Y value.
Expand	The range is 1~256, 1 in default.
Speed	Choose “Fast” / “Slow”. When choosing “Fast”, the CH1 and CH2 can only output the R/X/Y value.

Note that:

1. After setting the output configuration, click the button  to finish the configuration; all settings can be changed at the same time and you just need to click this button once.
2. After changing the settings, you need to click  to finish this configuration. Otherwise, the settings are void.

6.2.9 Aux Output Configuration

The sine output configuration is shown in the red box in Fig.68. Optional settings for users are shown in table 10.

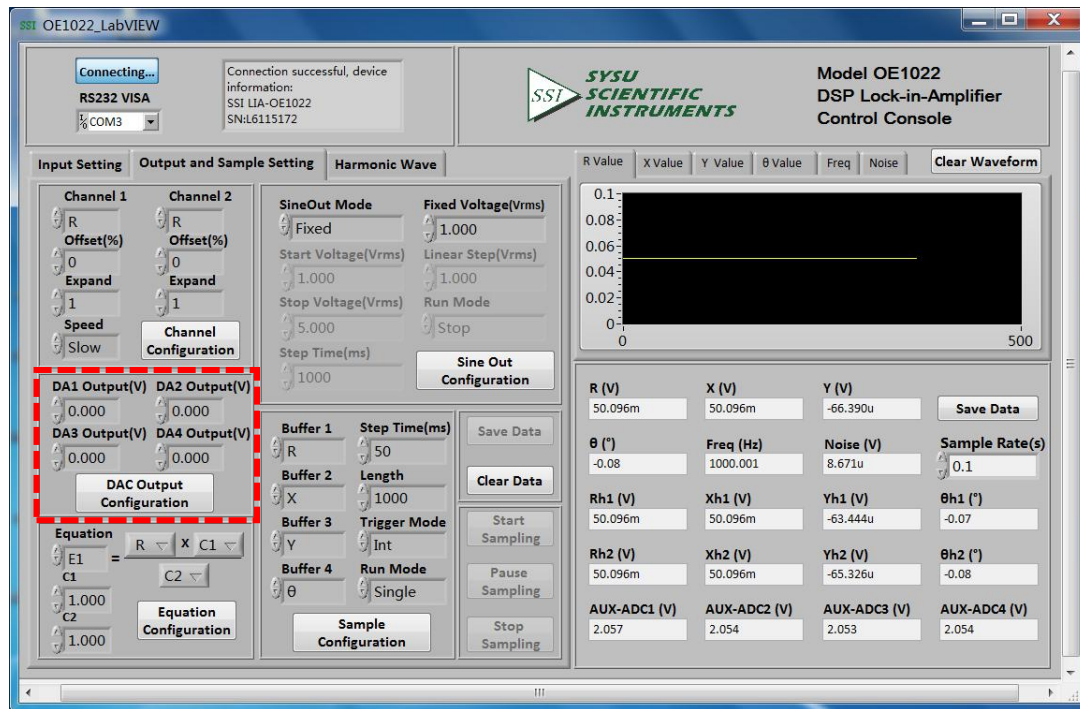
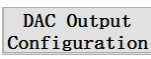
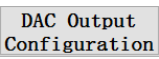

Fig.68 The Configuration Area of AUX OUTPUT

DA1 Output	Control the 4 AUX_DAC output AC voltage manually. The voltage range is from -10 V to 10 V and the minimum resolution is 1mV.
DA2 Output	
DA3 Output	
DA4 Output	

Note that:

1. After setting the output configuration, click the button  to finish the configuration.

All settings can be changed at the same time and you just need to click the button  once.

2. After changing the settings, you need to click this button to finish this configuration. Otherwise, the settings are void.

6.2.10 Custom Equation Configuration

The custom equation configuration is shown in the red box in Fig.69. The details of configuration are shown in Table 11.

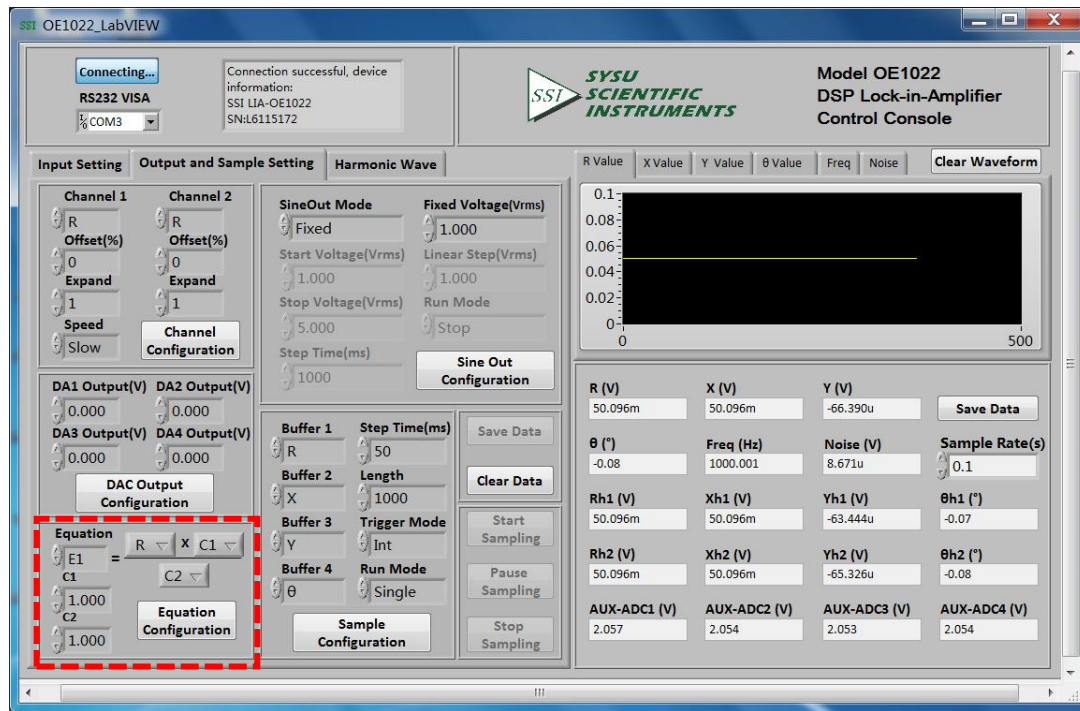

Fig.69 The Configuration Area of Equation

Table 11. Equation Configuration Options	
Equation	The output of Equation can be E1/E2/E3/E4. The input can be the X/Y/R/θ of signal or signal harmonic, the ADC1/ADC2/ADC3/ADC4 of AUX_ADC input, noise, frequency and C1/C2.
C1	Set the input of Equation manually. The range is -10~+10, and the minimum resolution is 0.001.
C2	

Note that:

1. After setting the output configuration, click the button **Equation Configuration** to finish the configuration.
- All settings can be changed at the same time and you only need to click the button **Equation Configuration** once.
2. After changing the settings, you need to click this button to finish this configuration. Otherwise, the settings are void.

6.2.11 Sine Output Configuration

The sine output configuration is shown in the red box in Fig.70. The details of configuration are shown in Table 12.

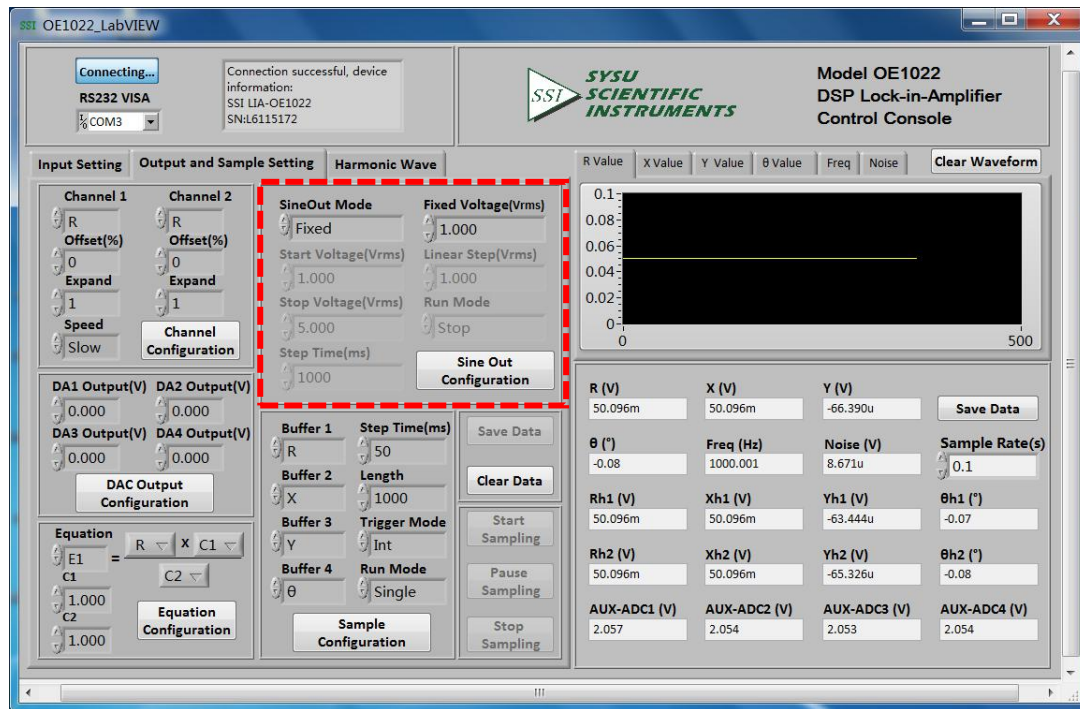

Fig.70 The Configuration Area of SINE OUTPUT

Table 12. Sine Output Configuration Options

Sine Out Mode	Fixed
	Linear
	Log
Sine Out Voltage (Vrms)	The Sine Out Mode is Fixed manually. The peak-peak voltage is 1mVrms to 5Vrms, the minimum resolution is 1 mVrms.
Sine Out Start Voltage (Vrms)	Set the start frequency of sweep manually. The frequency range is 1mVrms to 5Vrms, the minimum resolution is 1 mVrms.
Sine Out Stop Voltage (Vrms)	Set the stop frequency of sweep manually. The frequency range is 1mVrms to 5Vrms, the minimum resolution is 1 mVrms.
Step Time (ms)	Set the step time manually. The range is 1ms to 100s, the minimum resolution is 1 ms.
Linear Step (Vrms)	Set the step frequency manually. The range is 1mVrms to 5Vrms, the minimum resolution is 1 mVrms.
Sine Out Run Mode	Single
	Loop
	Stop

Note that:

1. After setting the output configuration, click the button **Sine Out Configuration** to finish the configuration. All settings can be changed at the same time and you just need to click this button once.
2. After changing the settings, you need to click **Sine Out Configuration** to finish this configuration. Otherwise, the settings are void.

6.2.12 Data Buffer Configuration

The data buffer configuration is shown in the red box in Fig.71. The details of configuration are shown in Table 13.

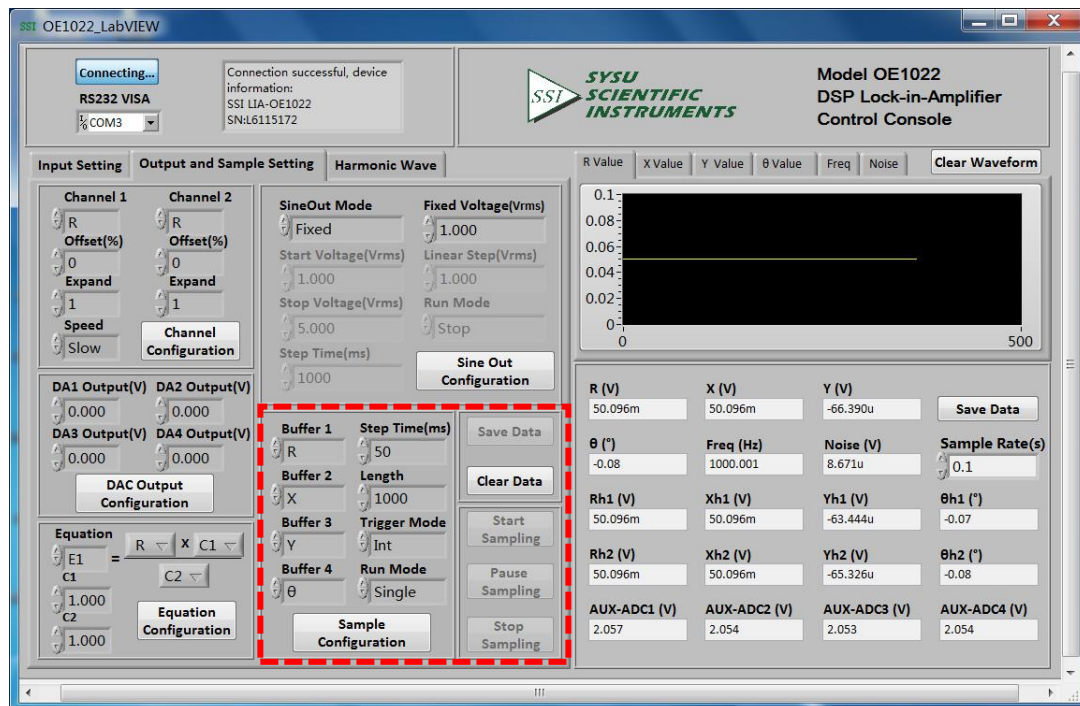
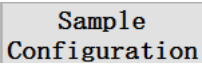
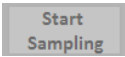
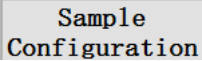
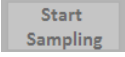
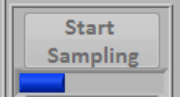

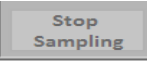
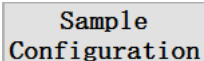



Fig.71 The Configuration Area of Data Buffer

Buffer 1	Users can choose the following value, the X/Y/R/θ of signal or signal harmonic, the ADC1/ADC2/ADC3/ADC4 of AUX_ADC input, noise, frequency, the E1/E2/E3/E4 of equation and C1/C2.
Buffer 2	
Buffer 3	
Buffer 4	
Step Time (ms)	Set the step time manually. The time range is 1ms to 100s, the minimum resolution is 1 ms.
Length	Set the data length manually. The length range is 1 to 16384, the minimum resolution is 1.
Int/Ext	Int
	Ext
Single/Loop	Single
	Loop

Note that:

1. After choosing all the settings, click the button  and then click the button  to start. Once settings are changed, you need to click  to update the configuration. Otherwise, the settings are void.

2. Click the button , and then there will be a progress bar  at the bottom of this button. This means the OE1022 has started sampling. The sampling will finish if the progress bar runs to 100%. During sampling, you can control the sampling progress by clicking the button  and . All settings can be set at the same time and you just need to click  once.

3. After finishing one sample, you can operate on the button  and . These two buttons are used to save and clear data in buffer.

4. After clicking the button , the interface will callout this window

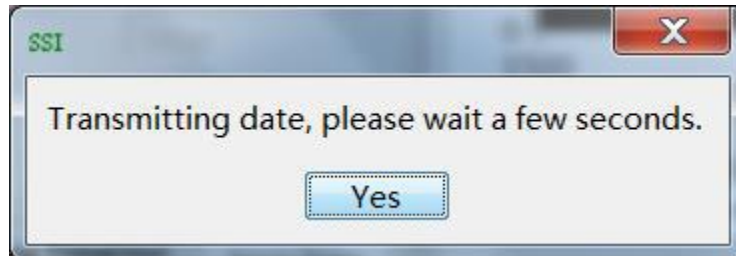

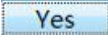
After clicking the button , the OE1022 starts to save data. There will be a progress bar

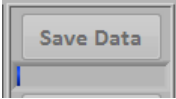
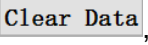
 at the bottom of this button. When the progress runs to 100%, the buffer finishes saving the data. Now an excel will be generated in current directory and its name is "Buffer_Data.xls". Click the button , then the 4 data buffers and the excel will be cleared.

6.2.13 Data Storage

The software has the function of data storage. Users can choose to save the data or not that OE1022 collects in a period.

The saved data contains the X/Y/R/ θ of measure signal or signal harmonic, frequency, noise and the ADC1/ADC2/ADC3/ADC4 of 4 AUX_ADC inputs.

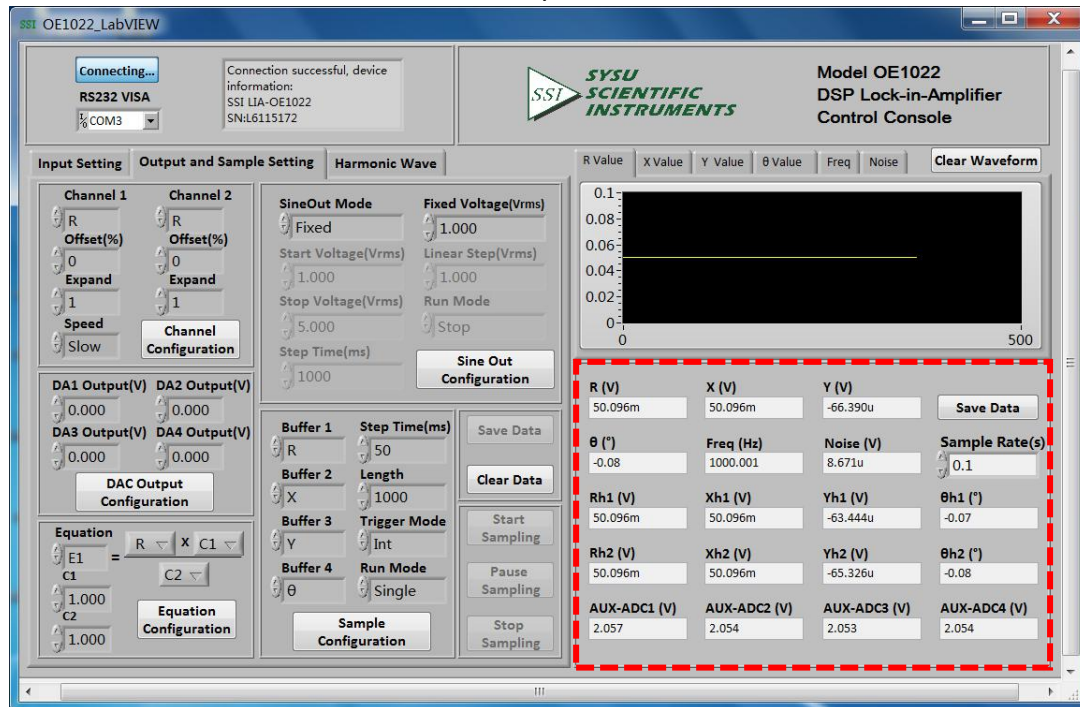

Fig.72 The Configuration Area of Data Storage

The steps for choosing to save data or not:

1. The data is saved in Excel. The file name is "Data_recorded_excel.xls". It is saved in the program directory.
2. When the software is executing, click the button **Save Data** in the red box in Fig.72. After clicking this button and it displays **Saving...**. The software is saving the current collected data.
3. Click the button **Saving...** again, and the button status will switch back to **Save Data** again. This means the software stops saving collected data.
4. In box **Sample Rate(s)**, you can modify the sampling rate of the current display and data storage. The input range is 0.1s ~ 100s.

6.2.14 Display Harmonic Waveform

Choose the “Harmonic Wave” option in left window of the software.

Now there are two XY coordinates charts to display harmonic. Users can choose to set it to display R/X/Y/ θ for each harmonic, as is shown in Fig.73.

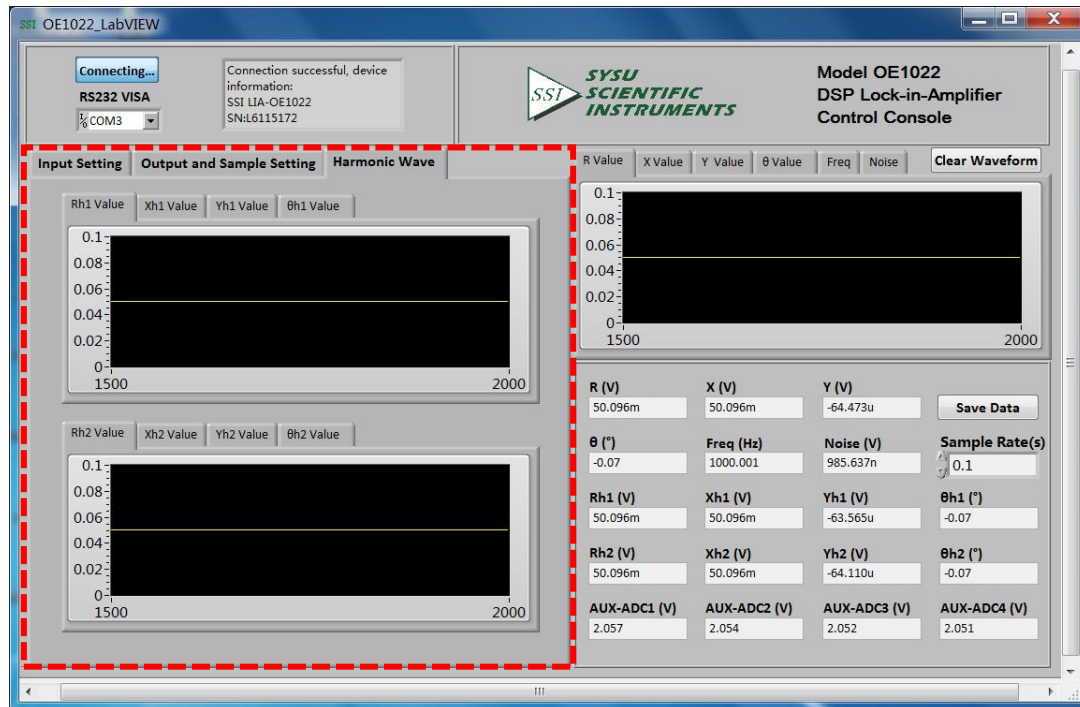

Fig.73 The Harmonic Waveform Display

6.3 Usage Examples

This example will show how to use OE1022 PC software to configure parameters, and observe and record the value of R/X/Y/θ.

First, connect the OE1022 and PC according to the software usage guidance in 6.2 and then you can start to configure.

Suppose that the lock-in amplifier configurations are shown in Table 14.

Input Source	Single-ended voltage input
Input Amplitude	40mV
Input Coupling	AC
Input Notch Filter	Close
Dynamic Reserve	Low Noise
Sensitivity	Auto Sensitivity
Reference Source	External reference, 1000Hz
Reference Signal Trigger Way	TTL rising edge trigger
Phase Shift Angle	0
Time Constant of Low Pass Filter	300ms
Roll Off	12 dB/oct
Sampling Rate	125Hz
Buffer 1	X
Buffer 2	Y

The steps to finish the configurations in table14 are as follows:

1. According to table 14, choose the following options in “Input Setting”, including “Input Source”, “Input Coupling” and “Input Notch Filter” with other options in default, as is shown in

Fig.74. At last, click the button **Input Configuration** to finish the configurations.

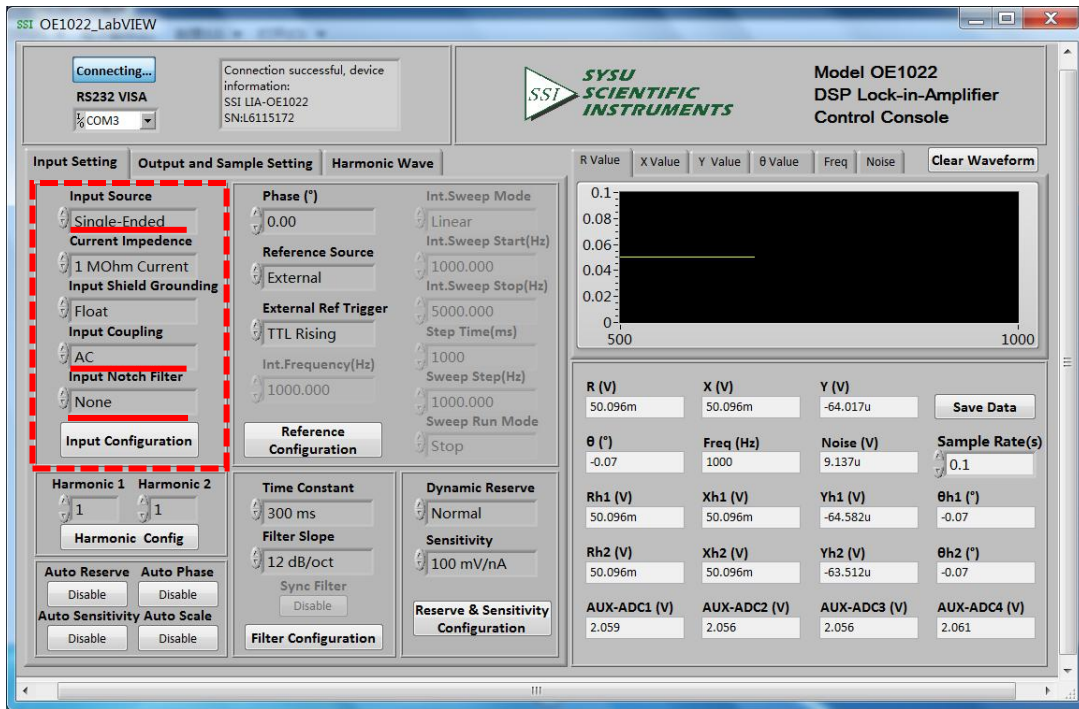

Fig.74 Input Configuration

2. Choose the following options in “Reference Configuration”, including “Phase”, “Reference Source”, “External Ref Trigger” with other options in default, as is shown in

Fig.75. At last, click the button **Reference Configuration** to finish the configurations.

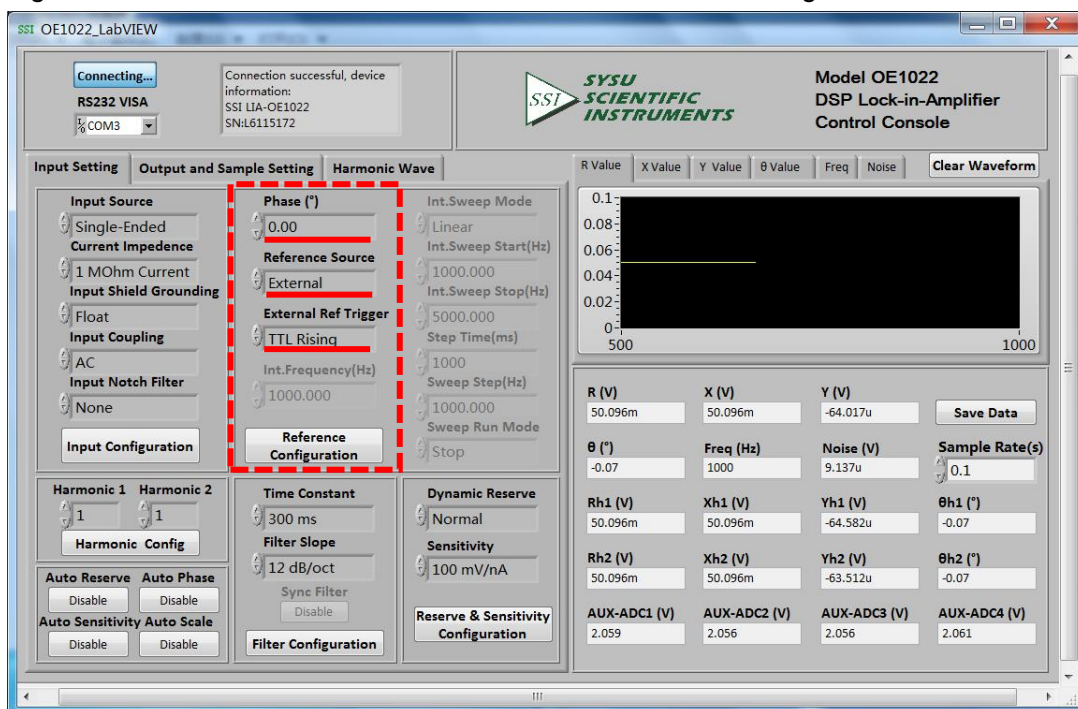

Fig.75 Reference Configuration

If you don't use "Auto Phase" and "Auto Scale" to set the phase shift and display scale automatically, do not click the corresponding button **Disable** and just keep it unchangeable. If you use "Auto Phase" to set phase shift angle automatically, you need to click the corresponding button **Disable**. When this button is clicked and it displays [being progressing]. The OE1022 will execute the auto phase function. After finishing this function, this button will reset to the original status **Disable**. Now the option "Phase" will update to the phase shift angle value that returned by OE1022.

3. Choose these two options in "Filter Configuration", including "Time Constant" and "Filter Slope" with other options in default, as is shown in Fig.76. At last, click the button

Filter Configuration to finish the configurations.

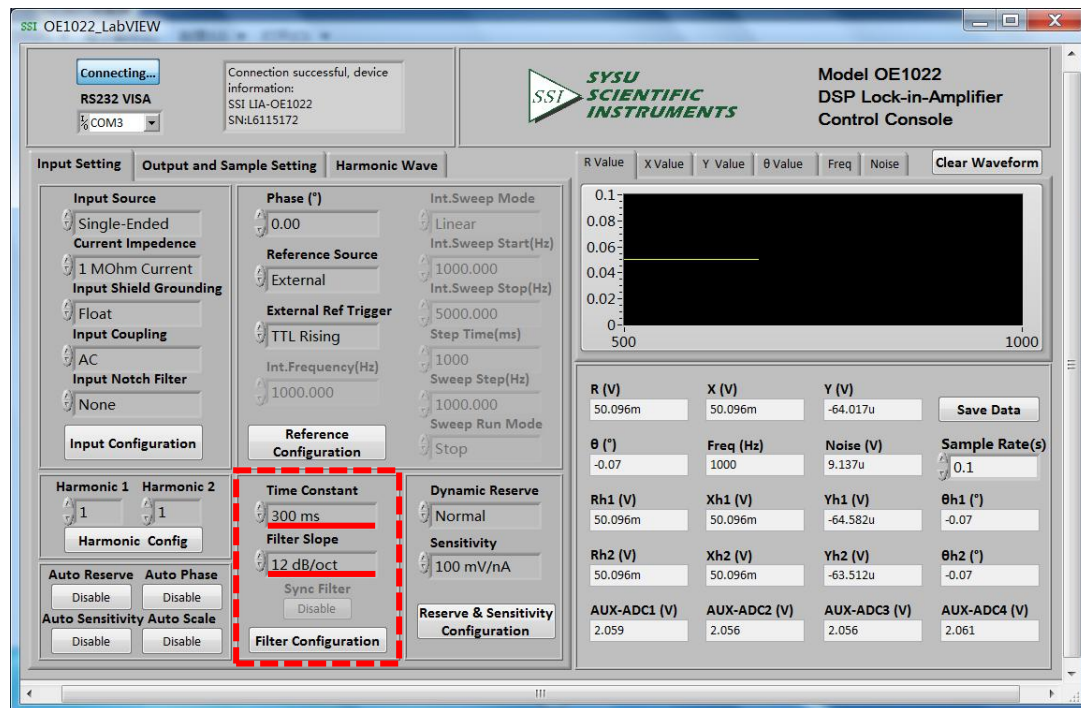

Fig.76 Filter Configuration

If you don't use sync filter, do not click the corresponding button [Close] and just keep it. If you use sync filter, click the corresponding button **Disable**. When this button is clicked and it displays "Open", the OE1022 has started the sync filter function. Click this button again and it will reset to the original status **Disable**. This means the OE1022 has closed this function.

4. Choose these two options in "Reserve & Sensitivity Configuration", including "Dynamic Reserve" and "Sensitivity" with other options in default, as is shown in Fig.77. At last,

click the button **Reserve & Sensitivity Configuration** to finish the configurations.

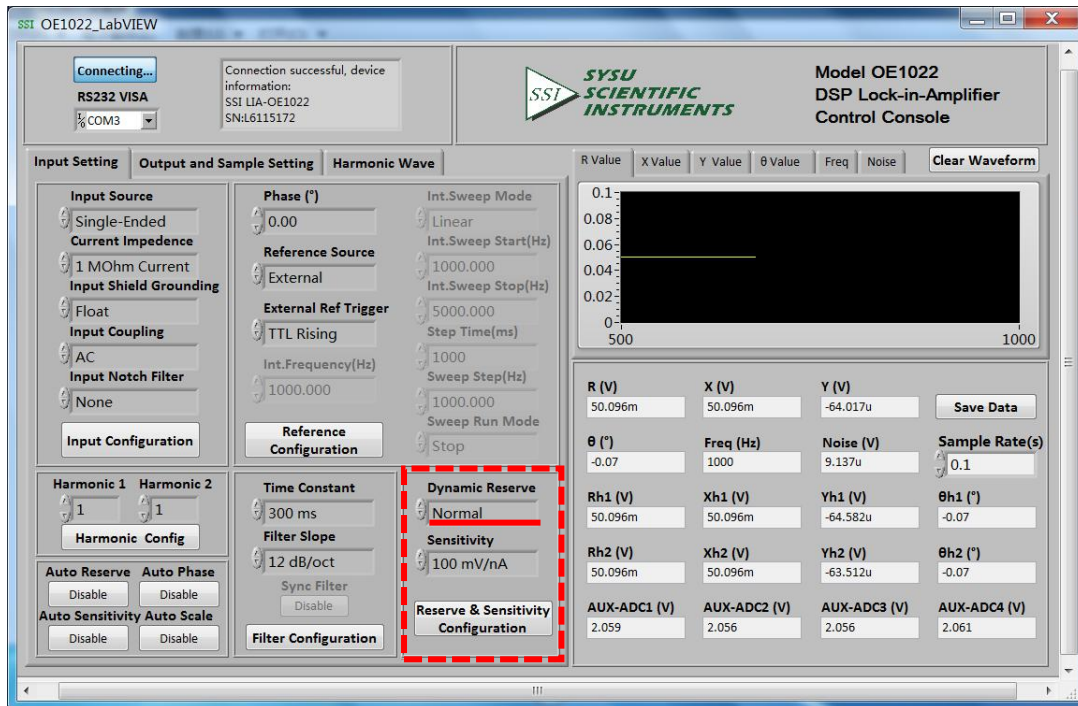

Fig.77 Reserve & Sensitivity Configuration

Use “Auto Sensitivity” to set sensitivity. Click the button **Disable** in Auto Sensitivity option. Then this button displays “Processing...” This means the OE1022 is executing auto sensitivity function. And after finishing this function, this button will reset to the original status **Disable**. Now the “Dynamic Reserve” and “Sensitivity” options will update to the values returned by OE1022. At this time, the “Sensitivity” option change to a suitable one contrasting with Fig.77, as is shown in Fig.78.

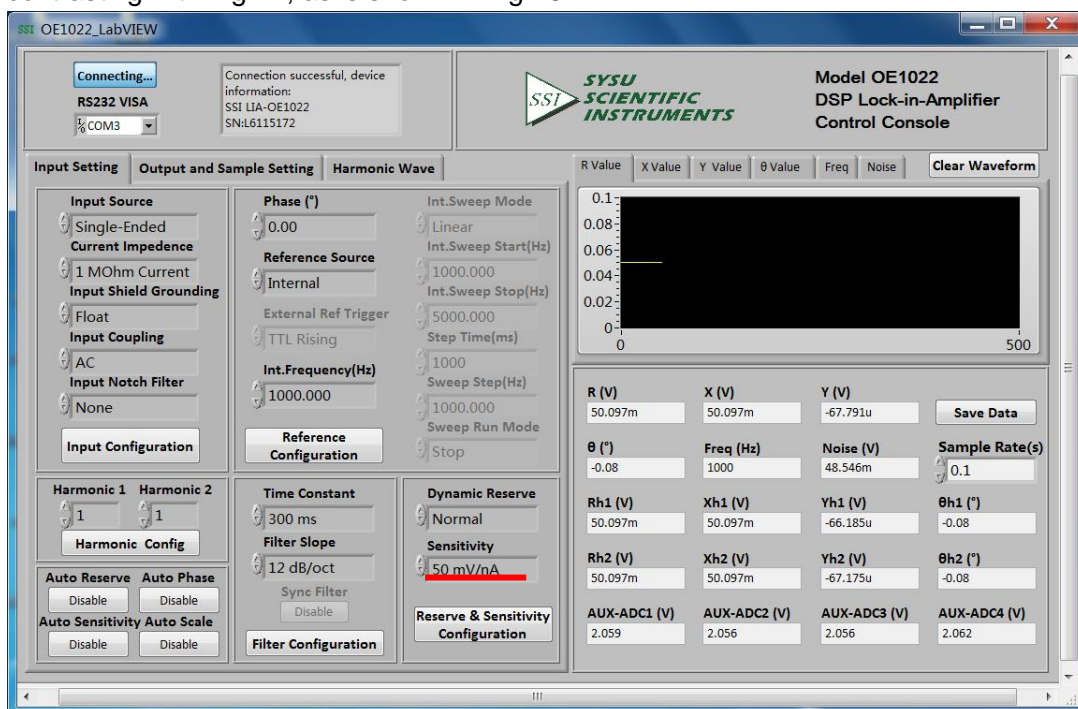

Fig.78 Auto Sensitivity Configuration

Compare the two OE1022 interfaces before and after configuration as is shown in Fig.79 and Fig.80, and you will see the configurations are successful.

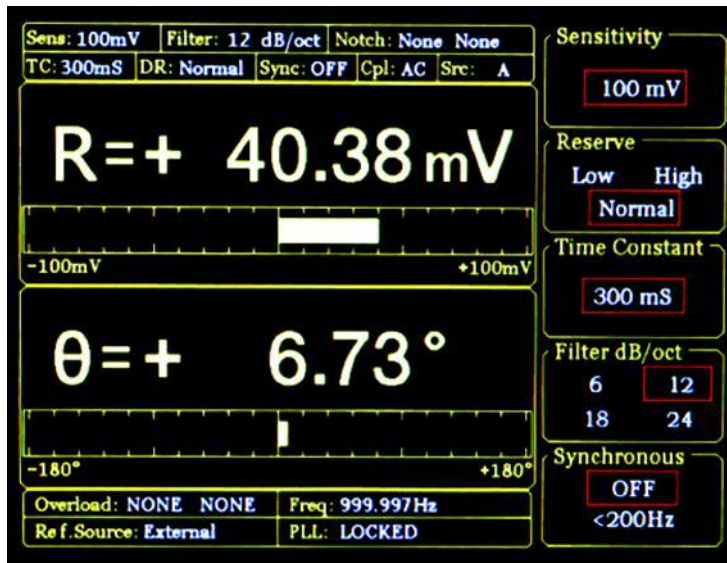

Fig.79 <SENS> is 100 mV before configuration

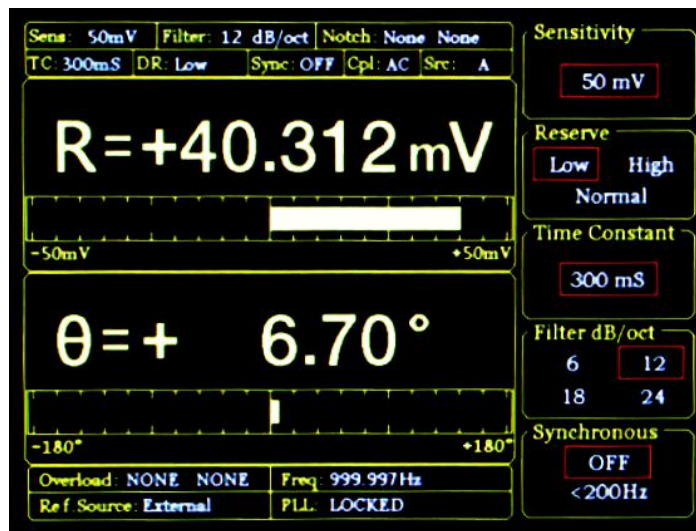

Fig.80 <SENS> is 50 mV after configuration

5. The configurations of OE1022 are finished. Other options are in default. Then users can collect and save data.

Data is saved in the selected directory in the form of an Excel. The file name is “Data_recorded_excel.xls” and it has 18 columns of data.

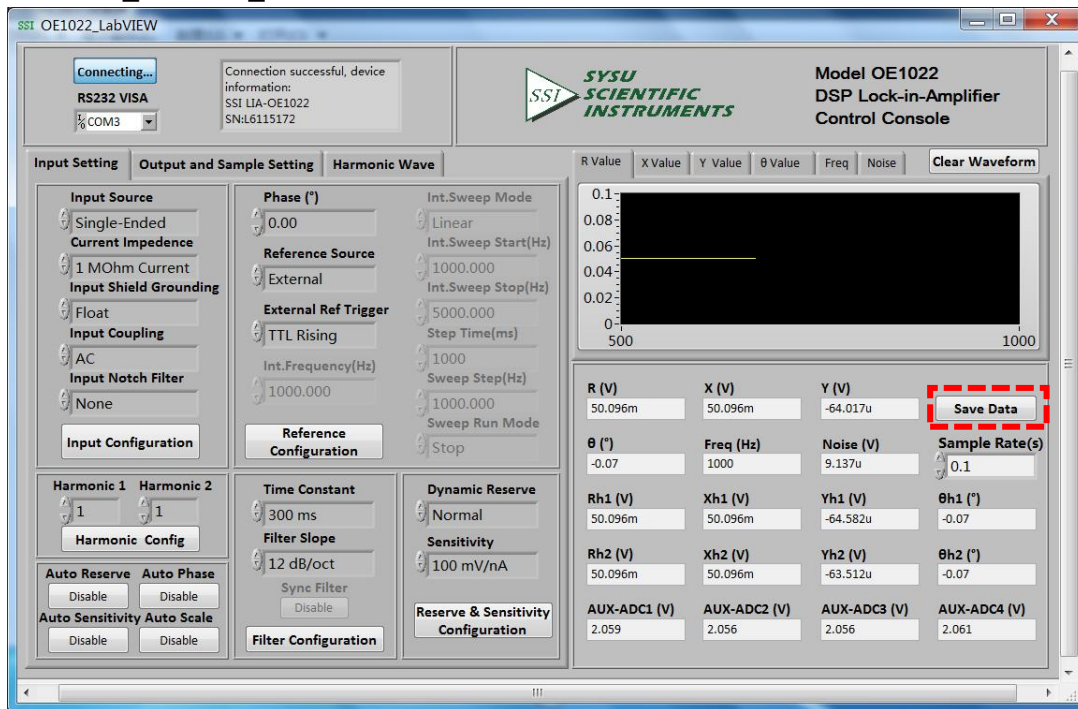

Fig.81 The data saving is paused

As is shown in Fig.81, click the button **Save Data** in the red box. When this button is clicked and it displays “**Saving...**”. This means the OE1022 is saving data, as is shown in Fig.82.

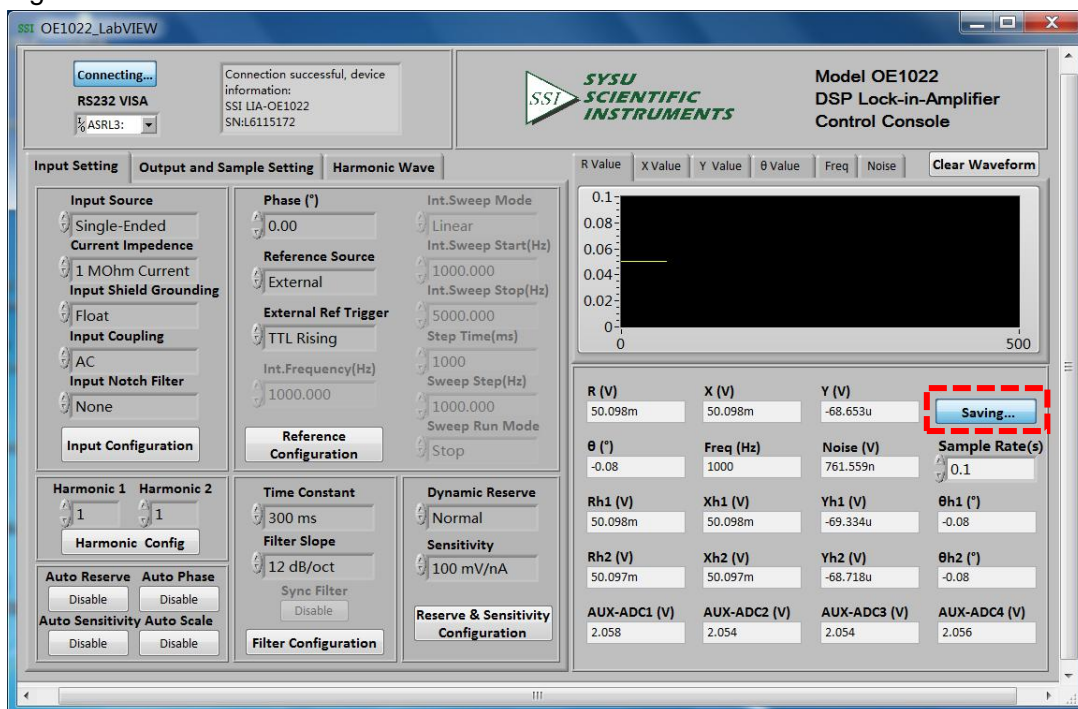

Fig.82 The data saving is executing

- There is another way to save data. Set different sampling rate according to users and save data in 4 buffers. One buffer can collect one kind of data. Data is saved in Excel in current directory. The file name is Buffer_Data.xls, as is shown in Fig.83.

Name	Date modified	Type
Data_recorded_excel.xls	8/16/2017 10:51 AM	Microsoft Excel 97...
OE1022_Console_EN.aliases	8/16/2017 10:57 AM	ALIASES File
SSI OE1022_Console_EN.exe	8/16/2017 10:57 AM	Application
OE1022_Console_EN.ini	8/16/2017 10:57 AM	Configuration sett...
Buffer_Data.xls	8/16/2017 10:53 AM	Microsoft Excel 97...

Fig.83 The Excel of Saved Data

The specific steps are below. (Suppose that the data sampling step time is 50ms, sampling length is 1000. The buffers 1~4 collect the value of R, X, Y, θ respectively.)

- Choose these options in the configuration area of data buffer, including data type, step time and length with other options in default. Then click the button **Sample Configuration** and then click the button **Start Sampling**. When there is a progress bar at the bottom of this button, the OE1022 starts to collect data, as is shown in Fig.84.

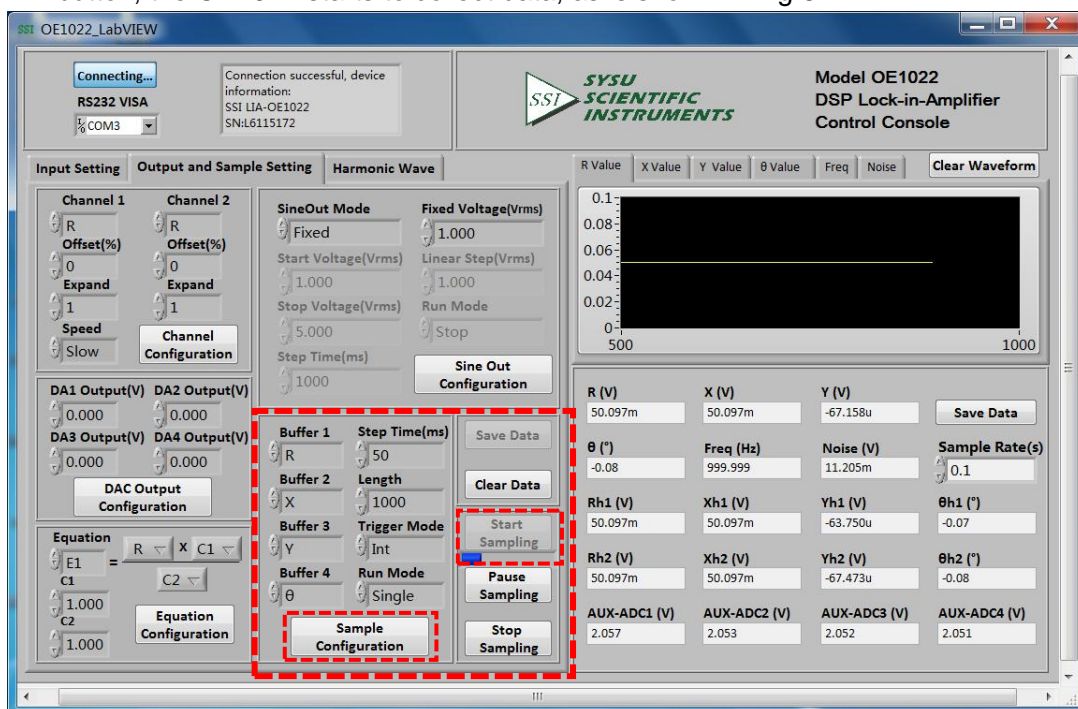

Fig.84 Data Collection

- When the progress bar runs to 100%, the collection of data is finished. Now if you want

to save data, just click the button **Save Data** in the red box in Fig.85.

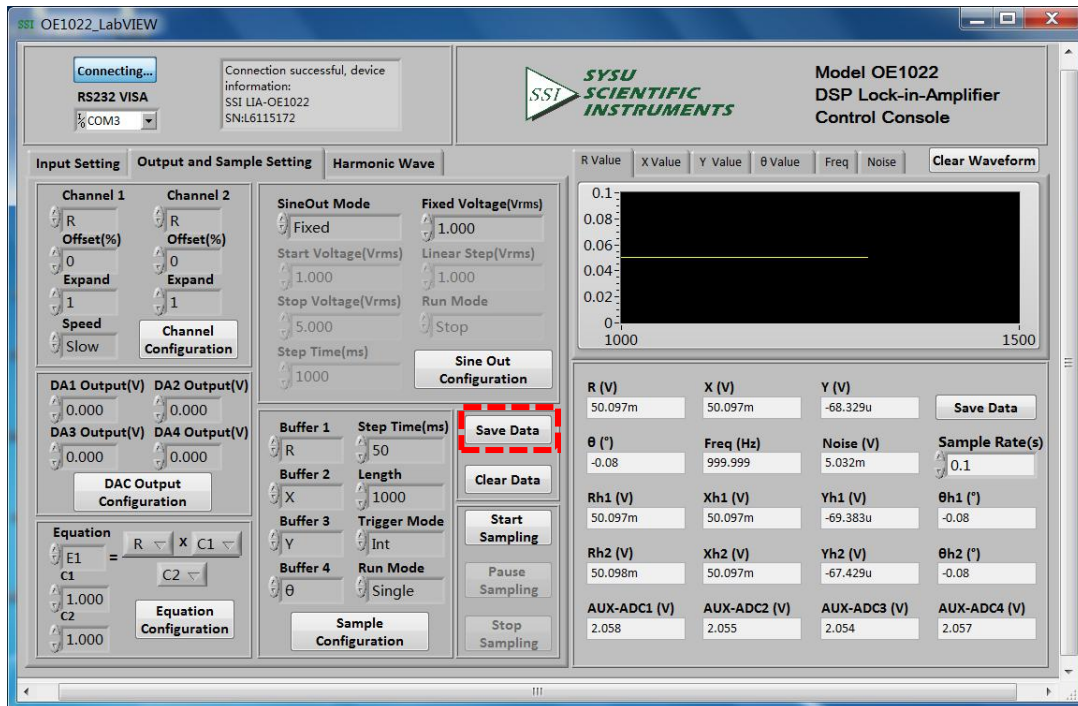

Fig.85 Save the Collected Data

As is shown in Fig.86, after clicking the button **Save Data**, there will be a progress bar at the bottom of this button. When the progress bar runs to 100%, the OE1022 has saved the collected data in buffers. Now four excel files will be generated in current directory.

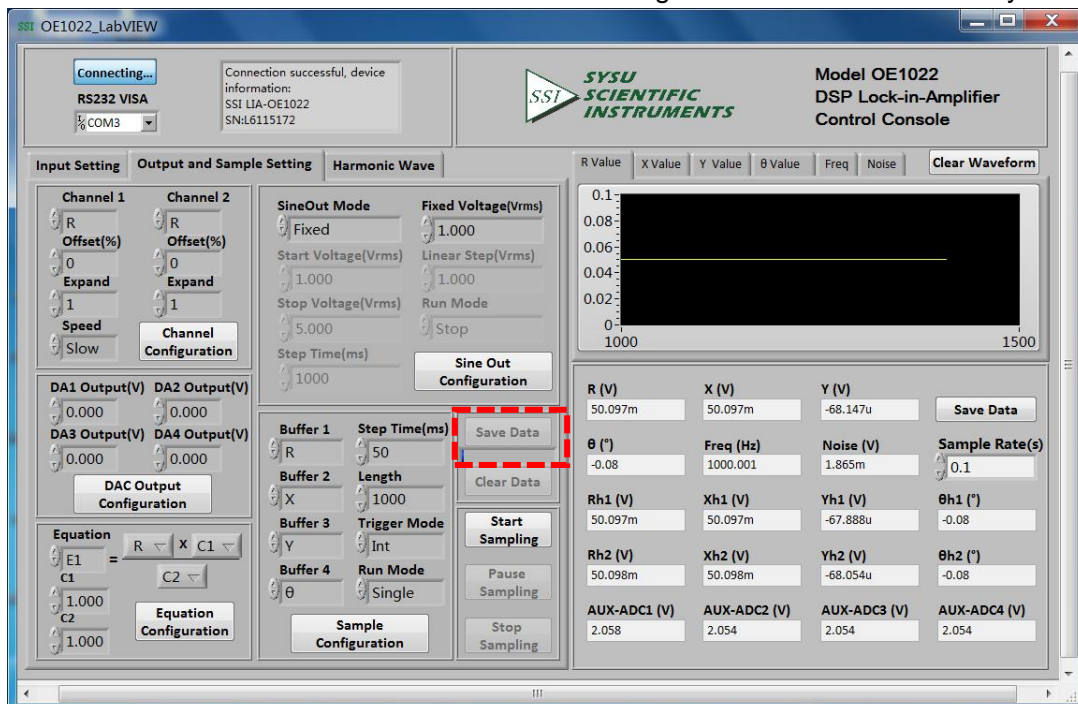

Fig.86 The Collected Data is saving

7. PERFORMANCE TESTS

Introduction	The performance tests are designed for users to prove that the OE1022 can operate normally and enhance users' confidence to our instrument. Each test can be recorded on the Performance Test Record form at the final section of this chapter.
Serial Number	If you have any questions and need to contact us, please offer the serial number of your unit. You can find the serial number on the CD box, the package box or the backside of your unit. You can also check the serial number at <Info> on the screen when the unit is powered on.
Firmware Revision	The firmware revision number is shown at <Info> on the screen when the unit is powered on.
Warm Up	Due to the temperature drift of chips, it is best to warm up the instrument for some time (30~60 minutes) in order to reduce measurement error.
Test Record	At the end of this section, there is a performance test record. It is necessary to make a copy of it before filling in the record. This record will allow you to determine whether the tests pass or fail and also preserve a record of the tests.
If a Test Fails	<p>If a test fails, you should check the settings and connections of any external equipment and internal equipment. If possible, verify its operation with a DVM, scope or other pieces of test equipment. After checking the settings, repeat this test from warm up and make sure that the test is performed correctly.</p> <p>If the test continues to fail, contact us for further instructions. Make sure that you have the unit's serial number and firmware revision code handy. Have the test record on hand as well.</p>

Necessary Equipment	<p>The following equipment is necessary to complete the performance tests. The suggested equipment or its equivalent should be used.</p> <p>1. Function Signal Generator</p> <table border="0"> <tr> <td style="padding-right: 20px;">Freq Range</td> <td>1 Hz to 1 MHz</td> </tr> <tr> <td>Freq Accuracy</td> <td>Better than 5 ppm</td> </tr> <tr> <td>Amplitude Accuracy</td> <td>0.2 dB from 1 Hz to 120 kHz</td> </tr> <tr> <td>Spurious</td> <td>≤ -55 dBc</td> </tr> <tr> <td>TTL SYNC</td> <td>Available</td> </tr> <tr> <td>Output Setup</td> <td>50 Ω or High Z</td> </tr> <tr> <td>Recommended</td> <td>AGILENT 33250A</td> </tr> </table> <p>2. Digital Voltmeter</p> <table border="0"> <tr> <td style="padding-right: 20px;">Voltage Range</td> <td>≥ 20 V, 4 1/2 digits</td> </tr> <tr> <td>Accuracy</td> <td>≤ 0.005 %</td> </tr> <tr> <td>Recommended</td> <td>KEITHLEY 2100</td> </tr> </table> <p>3. DC Voltage Source</p> <table border="0"> <tr> <td style="padding-right: 20px;">Voltage Range</td> <td>≥ 10 V</td> </tr> <tr> <td>Accuracy</td> <td>< 10mVpp</td> </tr> <tr> <td>Recommended</td> <td>RIGOL DP831A</td> </tr> </table> <p>4. Feedthrough Terminations</p> <table border="0"> <tr> <td style="padding-right: 20px;">Impedance</td> <td>50 Ω</td> </tr> </table>	Freq Range	1 Hz to 1 MHz	Freq Accuracy	Better than 5 ppm	Amplitude Accuracy	0.2 dB from 1 Hz to 120 kHz	Spurious	≤ -55 dBc	TTL SYNC	Available	Output Setup	50 Ω or High Z	Recommended	AGILENT 33250A	Voltage Range	≥ 20 V, 4 1/2 digits	Accuracy	≤ 0.005 %	Recommended	KEITHLEY 2100	Voltage Range	≥ 10 V	Accuracy	< 10mVpp	Recommended	RIGOL DP831A	Impedance	50 Ω
Freq Range	1 Hz to 1 MHz																												
Freq Accuracy	Better than 5 ppm																												
Amplitude Accuracy	0.2 dB from 1 Hz to 120 kHz																												
Spurious	≤ -55 dBc																												
TTL SYNC	Available																												
Output Setup	50 Ω or High Z																												
Recommended	AGILENT 33250A																												
Voltage Range	≥ 20 V, 4 1/2 digits																												
Accuracy	≤ 0.005 %																												
Recommended	KEITHLEY 2100																												
Voltage Range	≥ 10 V																												
Accuracy	< 10mVpp																												
Recommended	RIGOL DP831A																												
Impedance	50 Ω																												
Front Panel Display Test	<p>First, turn on the power switch on the rear panel to start the device. Second, check whether the display is lighted or not. Third, check whether there are bad pixels on the display. End the display test.</p>																												
Keypad Test	<p>After the device is started, press any button and you will hear “Di” sound once. Then, try to press every button to check whether the display change to the corresponding setting. Finally, press <Sensitivity> and spin the knob to check whether the knob is OK.</p>																												

7.1 Self-Test

The self-test checks the lock-in hardware. This test should be done before any other performance tests.

Device

No external device is required in this test.

Steps

1. Open the power switch on the rear panel to start the lock-in amplifier.
2. Observe the device, and check whether the screen, keyboard and cooling fan is OK.
3. Record the test results in the Performance Test Record.

7.2 DC Offset

This test measures the DC offset of the input.

Device

Connect a 50 Ω BNC cable to the A/I input. This shorts the input so the lock-in's own DC offset will be measured.

Steps

1. Turn the lock-in off and on to restart it.
2. Press the buttons in the following sequence:
 - <Ref. Source> Set to <Internal>
 - <Ref. Frequency> Set to 1Hz
 - <Sensitivity> Set to <1mV> through the spinning knob
3. Wait 10 seconds, then record the value of R.
4. Change the setting:
 - <Coupling> Set to <DC>
5. Wait 10 seconds, then record the value of R.
6. End the test and fill the result into the performance test form.

7.3 Common Mode Rejection

This test measures the common mode rejection of the lock-in.

Device

Use the internal oscillator sine output to provide the signal.

Connect the [SINE OUT] to both A and B inputs of the lock-in.

Use equal length cables from A and B to a BNC TEE.

Connect the cable from the [SINE OUT] to the TEE. Do not use any termination.

Steps

1. Turn the lock-in off and on to restart it.
2. Press the buttons in the following sequence:
 - <Sensitivity> Set to <1 V> through the spinning knob
 - <Ref. Source> Set to <Internal>
 - <Ref. Frequency> Set to 100 Hz
3. Wait until <R> is steady and <R> should be 1Vrms (within 3% error)
4. Press the buttons in the following sequence:
 - <Coupling> Set to <DC>
 - <Source> Set to <A-B>
 - <Sensitivity> Set to <200 μ V> through the spinning knob
5. Wait 10 seconds, and then record the value of R.
6. End the test. The common mode rejection equals to $20\lg(1/R)$, where R is in Volts(V).
Fill the results in the performance test form.

7.4 Amplitude Accuracy and Flatness

This test measures the amplitude accuracy and frequency response.

Device

Use the function signal generator to provide an accurate frequency and a sine wave. Use one cable with BNC connector to connect the output of the function signal generator to the A input of the lock-in. Use another cable with BNC connector to connect the reference output of the function signal generator to the REF IN of the lock-in.

Set the function signal generator to:

Function	Sine
Frequency	1 kHz
Amplitude	1 Vrms
Offset	0 V
Output	High Z
Sweep	off
Modulation	none

Steps

1. Turn the lock-in off and on to restart it.
2. Set <Filter> to 24 dB/oct.
3. Amplitude accuracy is verified at 1kHz and various sensitivities. Set the sensitivity of the lock-in and the amplitude of the function signal generator in the following sequence:

Sensitivity	Amplitude
1 V	1.0000 Vrms
200 mV	200.00 mVrms
100 mV	100.00 mVrms
20 mV	20.000 mVrms
10 mV	10.000 mVrms

- a) Set the function signal generator to the amplitude shown above.
 - b) Set <Sensitivity> of the lock-in.
 - c) Wait 10 seconds, then record <R>, then test the next group of the sensitivity-amplitude.
 - d) Repeat the steps from 3)-a) to 3)-c) until the Sensitivity-Amplitude test is completed.
4. Frequency response is checked at frequencies above 1kHz. Set the frequency in the following sequence:

Test Frequency

24 kHz
48 kHz
72 kHz
96 kHz
120 kHz

- a) Set <Sensitivity> of the lock-in to <200 mV>.
 - b) Set the frequency of the function signal generator to 1 kHz and the amplitude to 200.00mVrms.
 - c) Set the frequency of the function signal generator in the upper sequence.
 - d) Wait 10 seconds, then record <R>, then test the next frequency.
 - e) Repeat from 4)-c) to 4)-d) until all the frequencies are tested over.
5. End the test and fill the results in the performance test form.

7.5 Amplitude Linearity

This test measures the amplitude linearity. It tests how accurately the lock-in measures a signal smaller than full scale.

Device

Use a function signal generator to provide an accurate frequency and a sine wave.

Use a cable with BNC connector to connect the output of the function signal generator to the A/I input of the lock-in. Use another cable with BNC connector to connect the reference output of the function signal generator to the REF IN of the lock-in.

Set the function signal generator to:

Function	Sine
Frequency	1 kHz
Amplitude	1 Vrms
Offset	0 V
Output	High Z
Sweep	off
Modulation	none

Steps

1. Turn the lock-in off and on to restart it.
2. Set <Filter> to <24 dB/oct> and <Sensitivity> to <1 V>.
3. The Amplitude of the function signal generator should be 1kHz at various amplitudes.
Set the amplitude in the following sequence:

Amplitude
1.0000 Vrms
100.00 mVrms
10.000 mVrms

- a) Set the output amplitude of the function signal generator.
 - b) Wait 10 seconds, then record <R>, then test next amplitude.
 - c) Repeat from 3)-a) to 3)-b) until all amplitudes are tested over.
4. End the test and fill the results in the performance test form.

7.6 Frequency Accuracy

This test measures the frequency accuracy of the lock-in.

Device

Use the function signal generator to provide the reference signal.

Use one cable with BNC connector to connect the reference signal of the function signal generator to the REF IN of the lock-in.

Steps

1. Turn the lock-in off and on to restart it.
2. Set the frequency of the function signal generator to 10 kHz.
3. Wait until <PLL: UNLOCK> changes to <PLL: LOCKED>, then record <Freq>.
4. End the test and fill in the performance test form.

7.7 Sine Output Amplitude Accuracy and Flatness

This test measures the amplitude accuracy and frequency response of the internal oscillator SINE OUT.

Device

Use a 1-meter length cable with BNC connector to connect the SINE OUT to the A/I of the lock-in.

Steps

1. Turn the lock-in off and on to restart it.
2. Set <Sensitivity> to <1 V> and <Ref. Source> to <Internal>.
3. The frequency of the internal oscillator should be 1kHz steadily. Set <Sensitivity> and the amplitude of the SINE OUT in the following sequence:

Sensitivity	Sine Output
1 V	0.800 Vrms
500 mV	0.400 Vrms
200 mV	0.160 Vrms

- a) Set the amplitude of <SINE OUT>.
 - b) Set <Sensitivity>.
 - c) Wait 10 seconds, then record <R>, then test next group of Sensitivity-Sine Output.
4. Repeat from 3)-a) to 3)-c) until all the Sensitivity-Sine Output are tested over. Frequency response is checked at frequencies above 1 kHz. Set <Ref. Frequency> in the following sequence:

Test Frequencies
24 kHz
48 kHz
72 kHz
96 kHz

- a) Set <Sensitivity> to <1 V>.
 - b) Set the amplitude of the SINE OUT to <1Vrms>.
 - c) Set <Ref. Frequency> in the upper sequence.
 - d) Wait 10 seconds, then record <R>, then test next frequency.
 - e) Repeat from 4)-c) to 4)-d) until all the frequencies are tested over.
5. End the test and fill results in the performance test form.

7.8 DC Outputs and Inputs

This test measures the DC accuracy of the DC outputs and inputs of the lock-in.

Device

Use a linear DC regulator to generate a DC input.

Use a DVM to measure the DC output of the lock-in.

Connect a 50 Ω BNC termination to the A/I input of the lock-in.

Steps

1. Turn the lock-in off and on to restart it.
2. Set <Ref.Source> to <Internal>.
3. Follow the steps below:
 - a) Use a cable to connect CH1 or CH2 of the lock-in to the DVM. Set the DVM to 19.999 V range.
 - b) Set <Offset> of <Channel Output> in the following sequence:

Offset (%)
100.00
50.00
0.00
-50.00
-100.00
 - c) Waiting for 10 seconds and record the reading of the DVM. Then, test next group data.
 - d) Repeat steps 3-b) to 4-c) until finishing the tests for CH1. Then, connect the DVM to CH2 and continue to finish the tests for CH2.
4. Follow the steps below:
 - a) use signal cable to connect the DVM to the Lock-in AUX_OUT 1 on rear panel.
 - b) set <DA Output> of <AUX Output> in the following sequence

DA Output (V)
10.000
5.000
0.000
-5.000
-10.000
 - c) Wait 10 seconds and record the reading of the DVM. Then, test next group data.
 - d) Repeat steps 3b to 3c until finishing the tests for DA1. Then connect the DVM to DA2, DA3, DA4 to finish the tests for DA2, DA3, DA4.
5. Follow the steps below:
 - a) Set <Monitor> in <Display> to <Input>.
 - b) use signal cable to connect the AC regulator OUT to AUX_IN 1.
 - c) use signal cable to connect the AC regulator OUT to AUX_IN 1.

Voltage (V)

10.000

5.000

0.000

-5.000

-10.000

- d) Wait 10 seconds and recode the reading of <A1> at the top of the screen. Then, test the next group data.
 - e) Repeat steps 4c to 4d until finishing the tests for A1. Then connect the AC Regulator OUT to A2, A3, A4 and finish the tests for A2, A3, A4.
6. End the tests for DC inputs and outputs and fill the results in the performance test record form.

7.9 Input Noise

This test measures the input noise of the lock-in.

Device

Connect a 50 Ω BNC termination to the A/I input of the lock-in. This grounds the input so the lock-in's own noise is measured.

Steps

1. Turn the lock-in off and on to restart it.
2. Set the parameters in the following sequence:

<Ref. Source>	Set to <Internal>
<Ref. Frequency>	Set to 997 Hz
<Sensitivity>	Set to <100 nV> through the spinning knob
<Reserve>	Set to <Low>
<Filter>	Set to <24 dB/oct>
<Trace>	Set <Trace> in <Display> to <Noise>.

3. Wait until the reading is steady, and then record the maximum value of noise.
4. End the test and fill the result in the performance test form.

7.10 OE1022 Performance Test Record

OE1022 Performance Test Record				
Serial Number _____		Tested By _____		
Firmware Revision _____		Date _____		
Equipment Used _____				
1. Starting Tests				
	Pass		Fail	
	_____		_____	
2. DC Offset				
	Input Coupling	Reading		Upper Limit
	AC	_____		0.500mV
	DC	_____		0.500mV
3. Common Mode Rejection				
	Frequency	Reading		Upper Limit
	100Hz	_____		30 μ V
4. Amplitude Accuracy and Flatness				
Sensitivity	Amplitude	Lower Limit	Reading	Upper Limit
1V	1.0000Vrms	0.9800V	_____	1.0200V
200mV	200.00Vrms	198.99mV	_____	202.00mV
100mV	100.00Vrms	98.00mV	_____	102.00mV
20mV	20.000Vrms	19.60mV	_____	20.400mV
10mV	10.000Vrms	9.800mV	_____	10.200mV
Sensitivity	Amplitude	Lower Limit	Reading	Upper Limit
200mV	24kHz	196mV	_____	204mV
200mV	48kHz	196mV	_____	204mV
200mV	72kHz	196mV	_____	204mV
200mV	96kHz	196mV	_____	204mV
5. Amplitude Linearity				
Sensitivity	Amplitude	Lower Limit	Reading	Upper Limit
1V	1.0000Vrms	0.9900V	_____	1.0100V

100.00Vrms	0.0990V	_____	0.1010V
10.000Vrms	0.0099V	_____	0.0101V

OE1022 Performance Test Record

6. Frequency Accuracy

Frequency	Lower Limit	Reading	Upper Limit
10kHz	9.990kHz	_____	10.010kHz

7. SINE OUT Amplitude and Flatness

Sensitivity	SINE OUT Ampl.	Lower Limit	Reading	Upper Limit
1 V	2.000 Vpp (0.7071 Vrms)	0.6859 V	_____	0.7283 V
200 mV	0.400 Vpp (141.42 mVrms)	137.18 mV	_____	145.66 mV
50 mV	0.100 Vpp (35.355 mVrms)	34.294 mV	_____	36.416 mV
10 mV	0.020 Vpp (7.071 mVrms)	6.859 mV	_____	7.283 mV

SINE OUT Ampl.	Frequency	Lower Limit	Reading	Upper Limit
2.000 Vpp (0.7071 Vrms)	24 kHz	0.6859V	_____	0.7283V
	48 kHz	0.6859V	_____	0.7283V
	72 kHz	0.6859V	_____	0.7283V
	96 kHz	0.6859V	_____	0.7283V

8. DC Outputs and Inputs

Output	Offset	Lower Limit	Reading	Upper Limit
CH1	100.00	9.960V	_____	10.040V
	50.00	4.960V	_____	5.040V
	0.00	-0.020V	_____	0.020V
	-50.00	-5.040V	_____	-4.960V
	-100.00	-10.040V	_____	-9.960V

Output	Offset	Lower Limit	Reading	Upper Limit
CH2	100.00	9.960V	_____	10.040V
	50.00	4.960V	_____	5.040V
	0.00	-0.020V	_____	0.020V
	-50.00	-5.040V	_____	-4.960V
	-100.00	-10.040V	_____	-9.960V

Output	Voltage	Lower Limit	Reading	Upper Limit
AUX OUT 1	10.000	9.700 V	_____	10.300 V
	5.000	4.900 V	_____	5.100 V

0.000	-0.020 V	_____	0.020 V
-5.000	-5.100 V	_____	-4.900 V
-10.000	-10.300 V	_____	-9.700 V

OE1022 Performance Test Record

Output	Voltage	Lower Limit	Reading	Upper Limit
AUX OUT 2	10.000	9.700 V	_____	10.300 V
	5.000	4.900 V	_____	5.100 V
	0.000	-0.020 V	_____	0.020 V
	-5.000	-5.100 V	_____	-4.900 V
	-10.000	-10.300 V	_____	-9.700 V

Output	Voltage	Lower Limit	Reading	Upper Limit
AUX OUT 3	10.000	9.700 V	_____	10.300 V
	5.000	4.900 V	_____	5.100 V
	0.000	-0.020 V	_____	0.020 V
	-5.000	-5.100 V	_____	-4.900 V
	-10.000	-10.300 V	_____	-9.700 V

Output	Voltage	Lower Limit	Reading	Upper Limit
AUX OUT 4	10.000	9.700 V	_____	10.300 V
	5.000	4.900 V	_____	5.100 V
	0.000	-0.020 V	_____	0.020 V
	-5.000	-5.100 V	_____	-4.900 V
	-10.000	-10.300 V	_____	-9.700 V

Input	Voltage	Lower Limit	Reading	Upper Limit
AUX IN 1	10.000	9.960 V	_____	10.040 V
	5.000	4.960 V	_____	5.040 V
	0.000	-0.020 V	_____	0.020 V
	-5.000	-5.040 V	_____	-4.960 V
	-10.000	-10.040 V	_____	-9.960 V

Input	Voltage	Lower Limit	Reading	Upper Limit
AUX IN 2	10.000	9.960 V	_____	10.040 V
	5.000	4.960 V	_____	5.040 V
	0.000	-0.020 V	_____	0.020 V
	-5.000	-5.040 V	_____	-4.960 V
	-10.000	-10.040 V	_____	-9.960 V

Input	Voltage	Lower Limit	Reading	Upper Limit
AUX IN 2	10.000	9.960 V	_____	10.040 V
	5.000	4.960 V	_____	5.040 V
	0.000	-0.020 V	_____	0.020 V

-5.000	-5.040 V	_____	-4.960 V
-10.000	-10.040 V	_____	-9.960 V

OE1022 Performance Test Record

Input	Voltage	Lower Limit	Reading	Upper Limit
AUX IN 3	10.000	9.960 V	_____	10.040 V
	5.000	4.960 V	_____	5.040 V
	0.000	-0.020 V	_____	0.020 V
	-5.000	-5.040 V	_____	-4.960 V
	-10.000	-10.040 V	_____	-9.960 V

Input	Voltage	Lower Limit	Reading	Upper Limit
AUX IN 4	10.000	9.960 V	_____	10.040 V
	5.000	4.960 V	_____	5.040 V
	0.000	-0.020 V	_____	0.020 V
	-5.000	-5.040 V	_____	-4.960 V
	-10.000	-10.040 V	_____	-9.960 V

9. Input Noise

Frequency	Sensitivity	Reading	Upper Limit
1 kHz	100nV	_____	15 nV/ \sqrt{Hz}

8. OPERATION EXAMPLES

8.1 Simple Signal Measurements

This example will show how the OE1022 measure the value of R, X, Y, θ . You need two BNC cables to input the measurement signal and the reference signal. In this case, we use the function signal generator to generate a 80mVrms, 1kHz sine signal and use the OE1022 to measure it. The steps are below:

Measure a Sine Signal

1. Disconnect all cables from the lock-in. Connect the power source and then turn on the power switch. The system is in default now.
2. Use a BNC cable to connect the output of the function signal generator and the A/I input of the OE1022. Use another BNC cable to connect the reference signal of the function signal generator and the REF IN of the OE1022, as is shown in Fig.87.

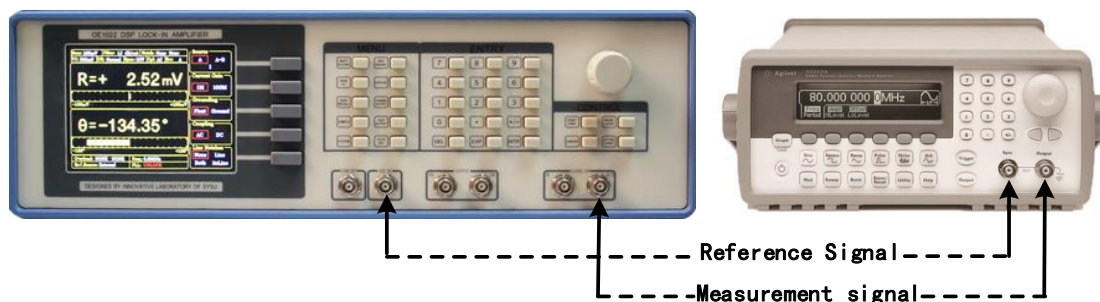

Fig.87 Signal Cable Connection Diagram

3. Turn on the function signal generator and set “Function: Sine”, “Amplitude: 80mVrms”, “Frequency: 1kHz”, “Output Impedance: High Z”, as is shown in Fig.88.

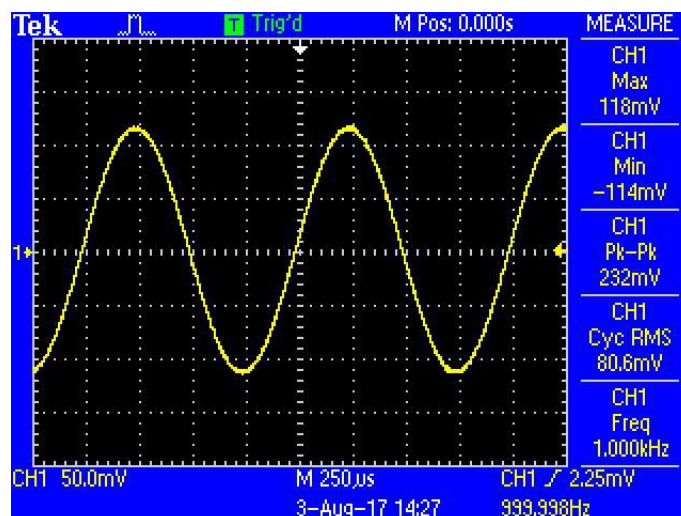

Fig.88 Parameters of Measured Signal

4. Turn on the output of the function signal generator and check whether the scale is overload by watching <Overload>.

Note that if the input of the preamplifier is overload, it shows <Overload: INPUT NONE>. If the output is overload, it shows <Overload: NONE GAIN>. If both the input and the output are overload at the same time, it shows <Overload: INPUT GAIN>.

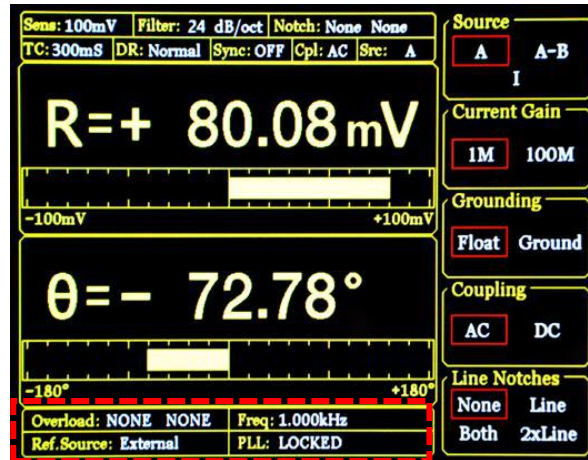

Fig.89 The Monitoring Bar of Main Interface

When the input of the preamplifier is overload, you should decrease the output amplitude of the function signal generator. If the output gain is overload, you should increase the sensitivity of the OE1022 (the input of the preamplifier will be overload when the peak value is larger than 1.7V or the valley value is lower than -1.7V). The default sensitivity is <100mV>. Therefore, in this example, it will not be overload with the output amplitude of 80mVrms. Be careful in other cases. If you need to adjust the sensitivity, the steps are as below.

5. Press [GAIN/TC] in front panel and then enter the submenu shown in Fig.91.

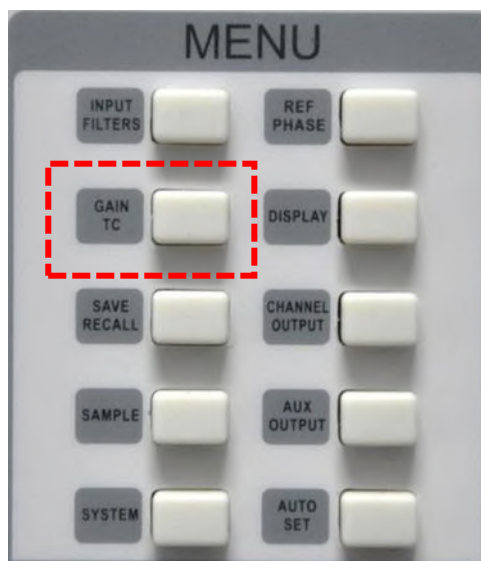

Fig.90 [GAIN/TC] Menu

Press [Soft Key 1] to choose <Sensitivity> and then it will be highlighted. Spin the knob to change the value of sensitivity so that there is no overload and the full scale is the maximum. In this case, we set the parameters as Fig.91. Then OE1022 measures the sine signal and the result is $R=80.08\text{ mV}$, $\theta=-72.78^\circ$.

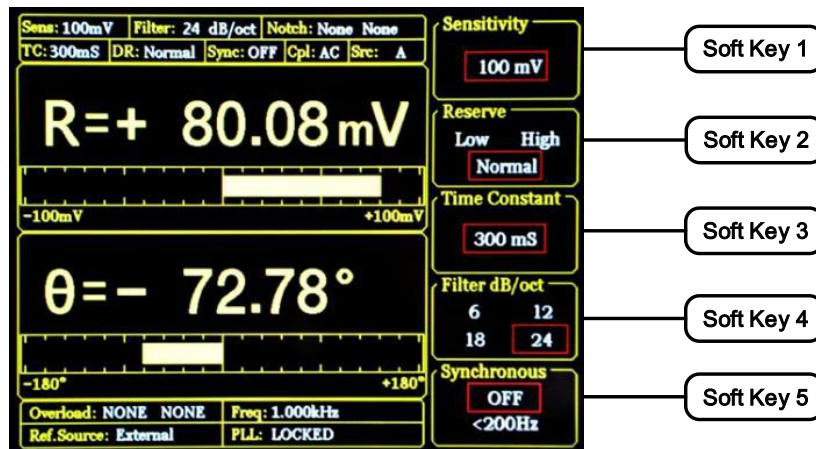

Fig.91 GAIN/TC Submenu

6. The data bar of main interface displays the value of <R>, <X>, <Y> and <theta>. Press [DISPLAY] in front panel to enter the submenu, as is shown in Fig 92 and 93.

In default settings, the top area displays <R> and the bottom area displays <theta>.



Fig.92 [DISPLAY]

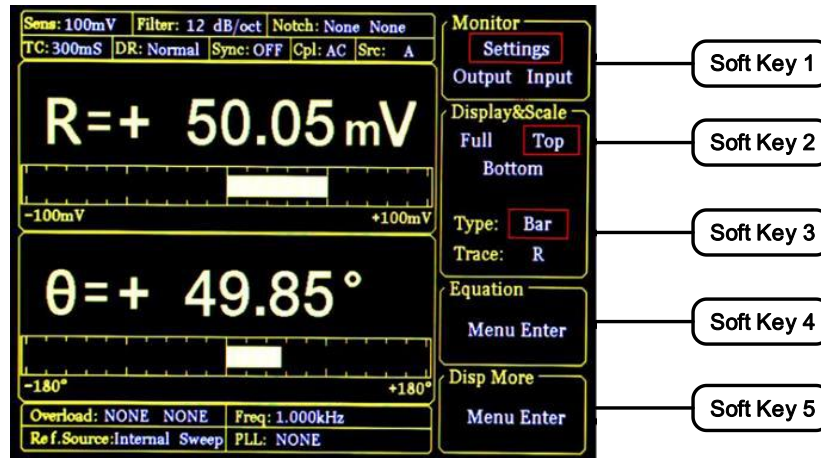

Fig.93 [DISPLAY] Menu Interface

Users can change which value to display as the following steps.

For example, how to display θ instead of R in top area with XY Coordinates Chart.

First, press [soft key 2] and choose \langle Top \rangle . Second, press [soft key 3] to highlight [Type] and then choose \langle Chart \rangle though the knob. Third, press [soft key 3] to highlight \langle Trace \rangle and then choose \langle θ \rangle . After these settings, the result is shown in Fig.94.

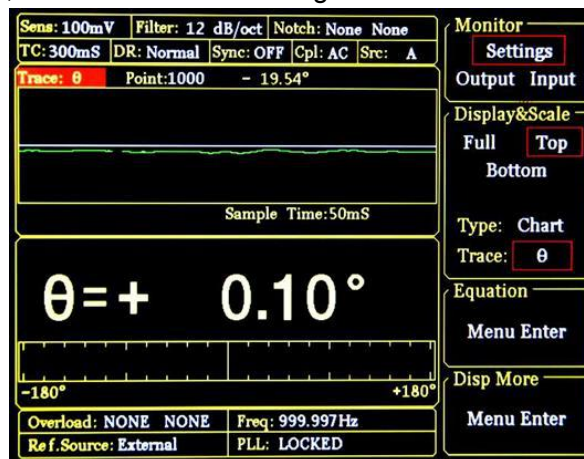

Fig.94 Display \langle θ \rangle in XY Chart

7. The monitor bar of main interface displays the value of \langle R \rangle , \langle X \rangle , \langle Y \rangle and \langle θ \rangle .

Users can change which value to display as the following steps:

Press [DISPLAY] in front panel to enter the submenu. Then, press [soft key 1] to set the \langle Monitor \rangle from \langle Setting \rangle to \langle Output \rangle . Now the monitor bar will display the value of \langle R \rangle , \langle X \rangle , \langle Y \rangle and \langle θ \rangle , as is shown in Fig.95.

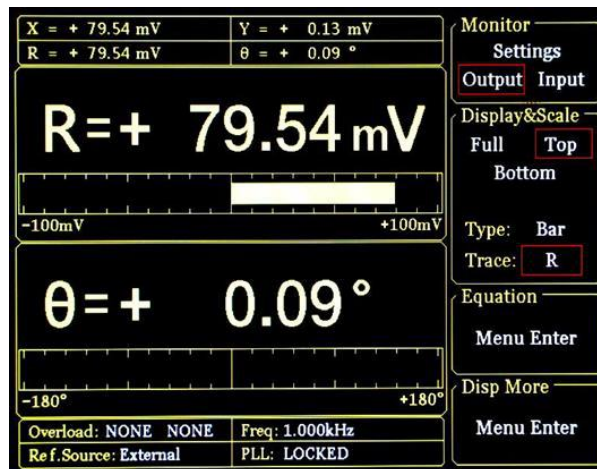

Fig.95 Monitoring Bar Display

8.2 Harmonics Measurements

This example will show how to measure harmonic component of the input signal. You need two BNC cables to input the measured signal and the reference signal. Use the function signal generator to provide a 160mVpp, 1 kHz square wave and then measure the first and third harmonic with the OE1022. The steps are below.

1. Disconnect all cables from the lock-in. Connect the power source and then turn on the power switch. The system is in default.
2. Use a BNC cable to connect the output of the function signal generator and the A/I input of the OE1022. Use another BNC cable to connect the reference signal of the function signal generator and the REF IN of the OE1022, as is shown in Fig.96.

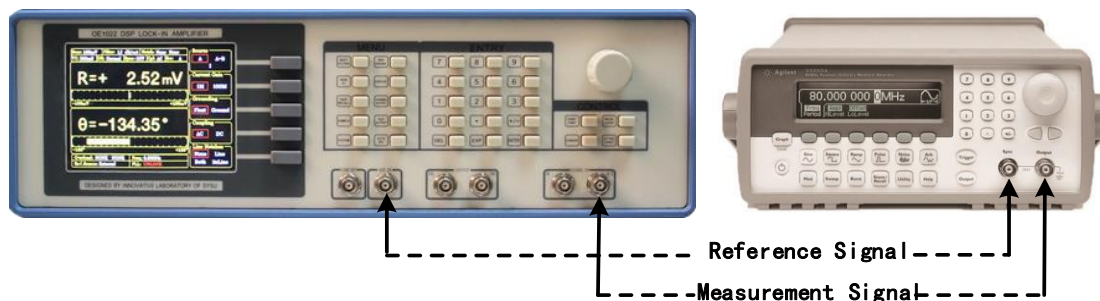

Fig.96 Signal Cable Connect Diagram

3. Turn on the function signal generator and set "Function: Square", "Amplitude: 80mVrms", "Frequency: 1 kHz", as is shown in Fig.97.

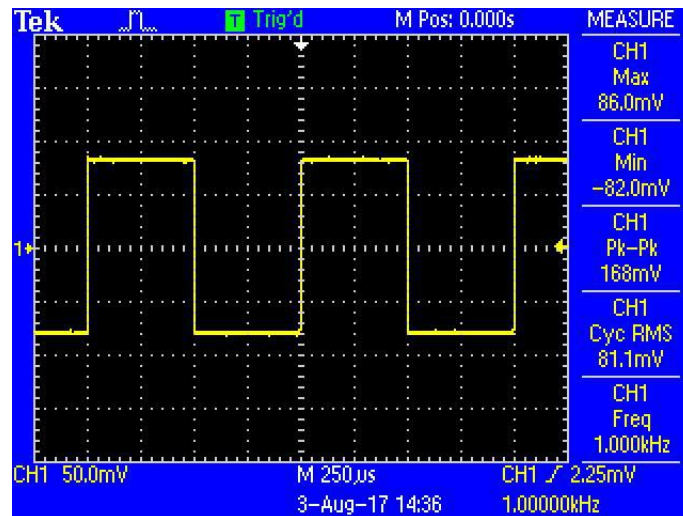

Fig.97 Measured Signal Parameter

4. Press [REF PHASE] in front panel and set <Harmonic> to the required order, as is shown in Fig.98.



Fig.98 [REF PHASE] Submenu

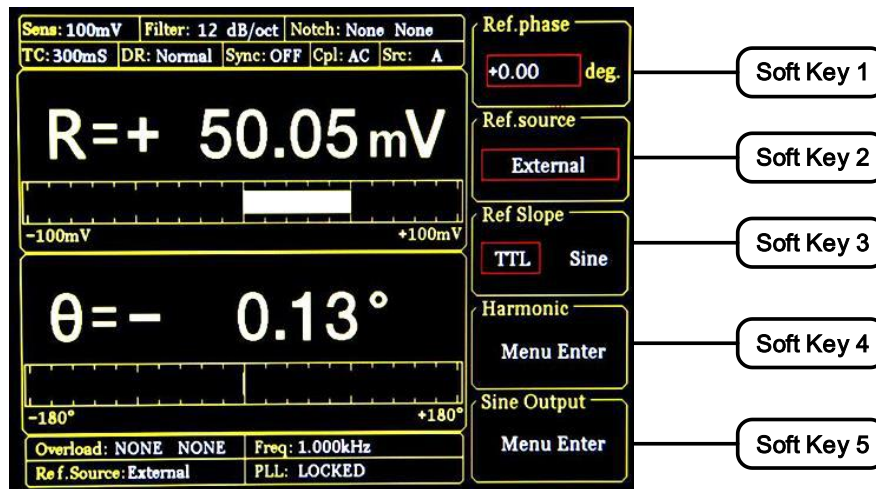

Fig.99 REF PHASE Submenu

Set the harmonic number in <Harmonic> secondary submenu and use the keyboard to input the required order.

The operation steps of measuring the first and third harmonic of the input square wave is below. First, press the [soft key 4] in [REF PHASE] menu to choose [harmonic] submenu as is shown in Fig.100.

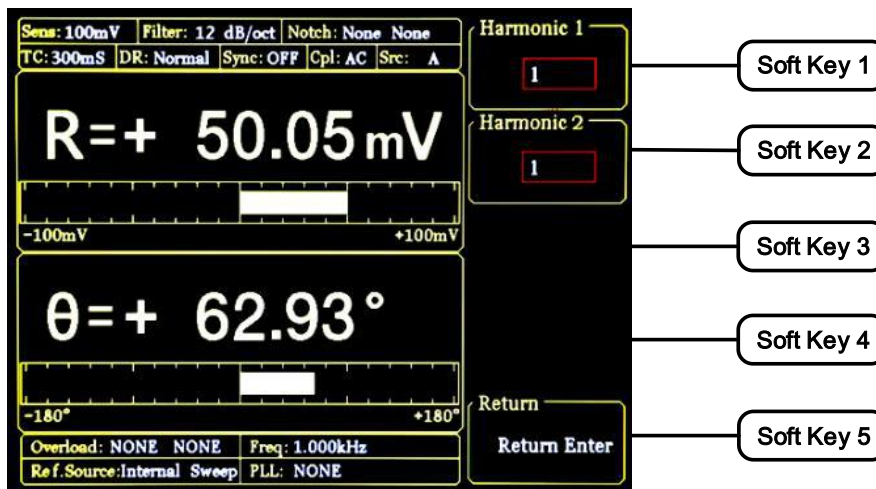

Fig.100 Harmonic Secondary Submenu

Second, press [soft key 1] and then press the number key [1] in numeric keyboard. Then press [ENTER] to confirm. Third, press [soft key 2] and then number key [3]. Now the measure result is the first and third harmonic of the input signal.

Choose [DISPLAY] submenu and choose <Full> in <Display & Scale> option and <List> in <Type> option. Then, you can read the measured harmonic (harmonic 1 is corresponding to <Xh1>, <Yh1>, <Rh1> and <θh1>; harmonic 2 is corresponding to <Xh2>, <Yh2>, <Rh2> and <θh2>). The result is shown in Fig.101.

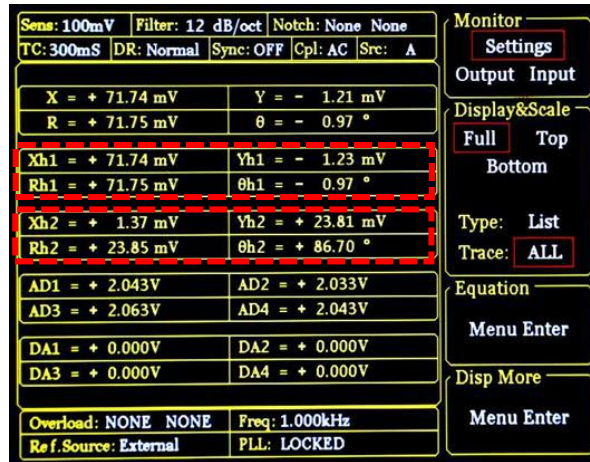

Fig.101 The 3th Harmonic Measurement Result

How to get the amplitude of the nth harmonics

How to calculate the harmonic theoretical value of the square wave: suppose that the peak-peak value of square value is E and the angular frequency is ω. After Fourier expand, the result is:

$$f(t) = \frac{2E}{\pi} \left(\sin(\omega t) + \frac{1}{3} \sin(3\omega t) + \frac{1}{5} \sin(5\omega t) \cdots + \frac{1}{n} \sin(n\omega t) \right)$$

Where the nth harmonic is a sine wave:

$$f(t) = \frac{2E}{n\pi} \sin(n\omega t)$$

Therefore, the valid value of the nth harmonic is:

$$R = \frac{\sqrt{2}E}{n\pi}$$

We can verify that whether the measured result is close to the theoretical result. In this example, the peak-peak value E is 160mV, and the calculated value of first harmonic is:

$$R = \frac{\sqrt{2} \times 160}{1 \times \pi} mV \approx 72.025 mV$$

The calculated value of third harmonic is:

$$R = \frac{\sqrt{2} \times 160}{3 \times \pi} mV \approx 24.008 mV$$

Compare the measured result with theoretical result according the above method.

8.3 Optical Spectral Measurements

This case shows how to measure a spectral diagram of any light source. You need an optical chopper (such as SIGNAL RECOVERY MODEL 197 Light Chopper), a grating monochromator (such as WDG15-Z) and its control system, a photoelectric detector (such as the S286 series photodiode of Japan Hamamatsu Company), a data collection platform (such as NI cDAQ-9172) and a PC. You should control the monochromator to sweep automatically in the spectral measurement range. Then measure the photo current by the OE1022. The steps are as follows:

1. Disconnect all cables from the lock-in. Connect the power source and then turn on the power switch. The system is in default.

2. Set the corresponding parameters of OE1022.

- (1) Press [INPUT/FILTERS] and then set the input mode to <l> and <Amplitude: 1M>. Other settings remain the default.
- (2) Press [REF/PHASE] and then set <Ref. Source: External> and <Type: TTL>.
- (3) Press [GAIN/TC] and then set <Sensitivity: 1 μ A> which can be adjusted in measurement, <Reserve: Normal>, <TC: 300ms> and <Roll off: 12dB/oct>. Finally, turn off the SYNC filter.
- (4) Press [OUTPUT/OFFSET] and then set <CH1>, <Source: R> and <Speed: Fast>.

3. Build up the spectral measurement platform.

Use a BNC cable to connect the output of the photoelectric detector and the A/I input of the OE1022.

Use a BNC cable to connect the Sync out f1 of the optical chopper and the REF IN of the OE1022.

Use a BNC cable to connect the data collection platform and the CH1 OUT of the OE1022.

The sketch is shown in Fig.102

The actual connect figure is shown in Fig.103.

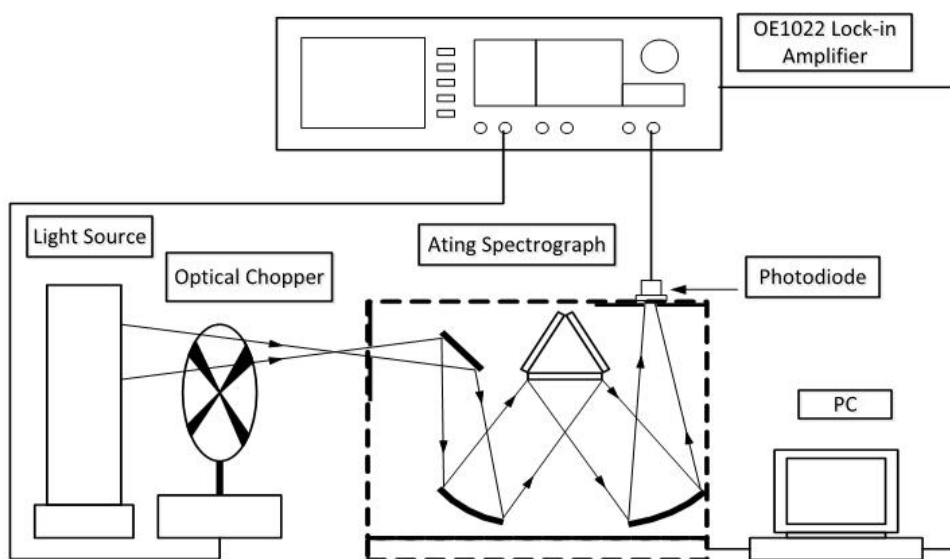

Fig.102 Spectral Measurement Platform Diagram

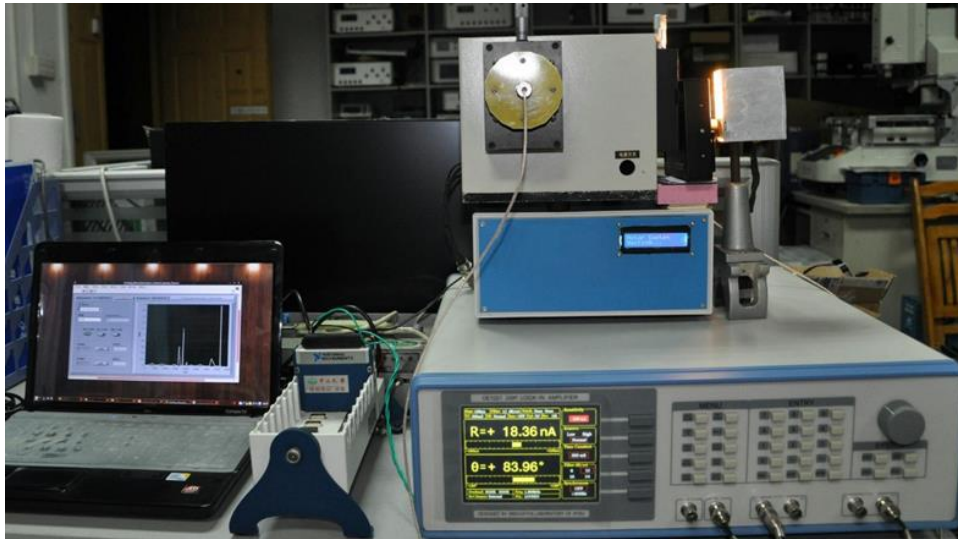

Fig.103 Spectral measurement platform physical connection

4. Start the spectral measurement and collect data from the data collection platform. Then, you will get an uncalibrated spectral curve as is shown in Fig.104

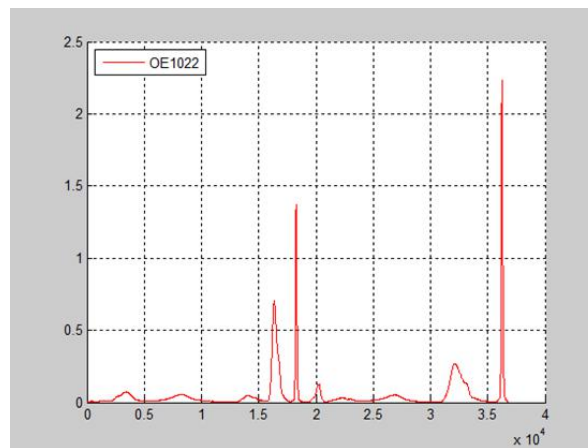

Fig.104 Spectrum Curve measured by OE1022

5. Use the SR830 instead of the OE1022 to measure. Repeat the steps above to run the same experiment. Then you will get another spectral curve as is shown in Fig.105. You can see that these two curves measured by OE1022 and SR830 are almost the same.

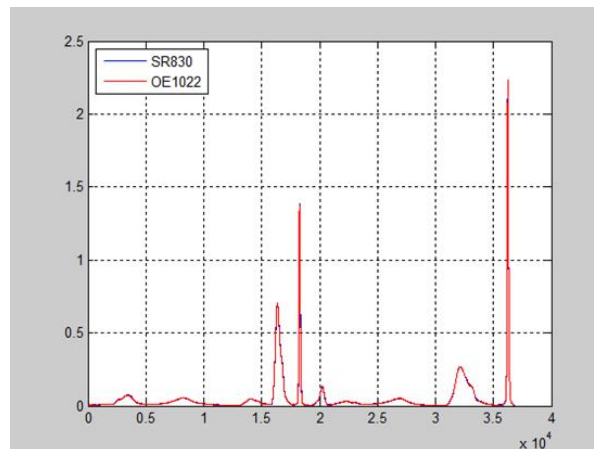

Fig.105 The Contrast Spectrum Curve between SR830 and OE1022

8.4 Serial Communication

This case shows how to remotely run the serial communication. You need a USB cable. The steps are as follows:

1. Use a USB cable to connect the USB of the OE1022 to the USB of the PC.
2. The PC will recognize the USB device and remind to install the driver program. If your PC system is WIN7, the PC will do these automatically online. You just need to wait for a few minutes. If the installation fails, you need to install the driver manually according to Chapter 6.2.
3. Open the folder "Uart Driver" in your disk and double click the file UartAssist.exe. It will call out the software interface, as is shown in Fig.106.

Note that this software can set the communication mode, the receiver mode, the transfer mode. The default Baud rate of the OE1022 is 921600. The OE1022 has no parity bit, 8 data bits and 1 stop bit. The port number choose the COM number automatically assigned by the PC. Users can check it at the 'COM and LPT' option in Device Manager of the PC, as is shown in Fig.107.

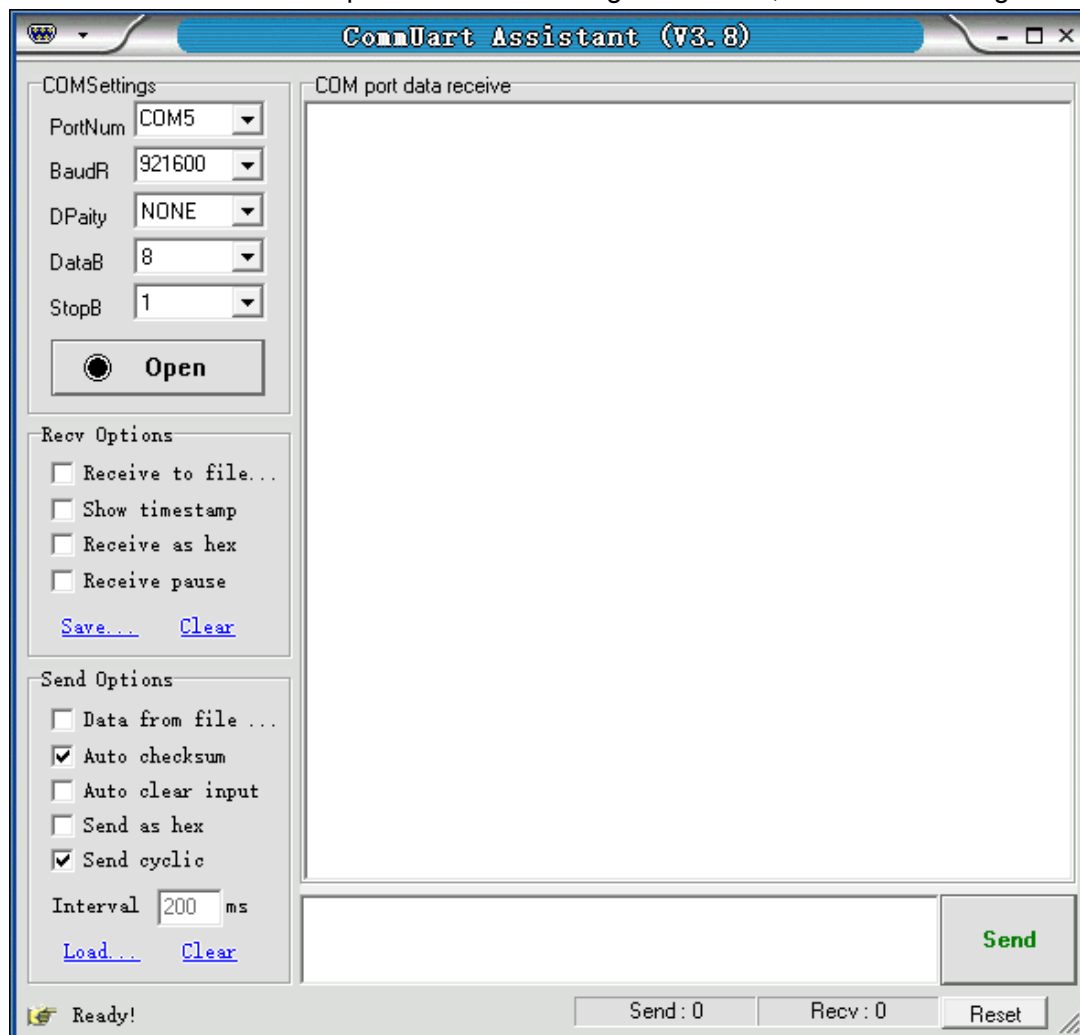



Fig.106 "CommUart Assistant" Software display

- 2) After these settings are completed, if you see a black circle like , you need to click the button to make it red like . If you cannot make it red, please check the port

number and repeat the connection. If the connection is OK, you will see Fig.108.

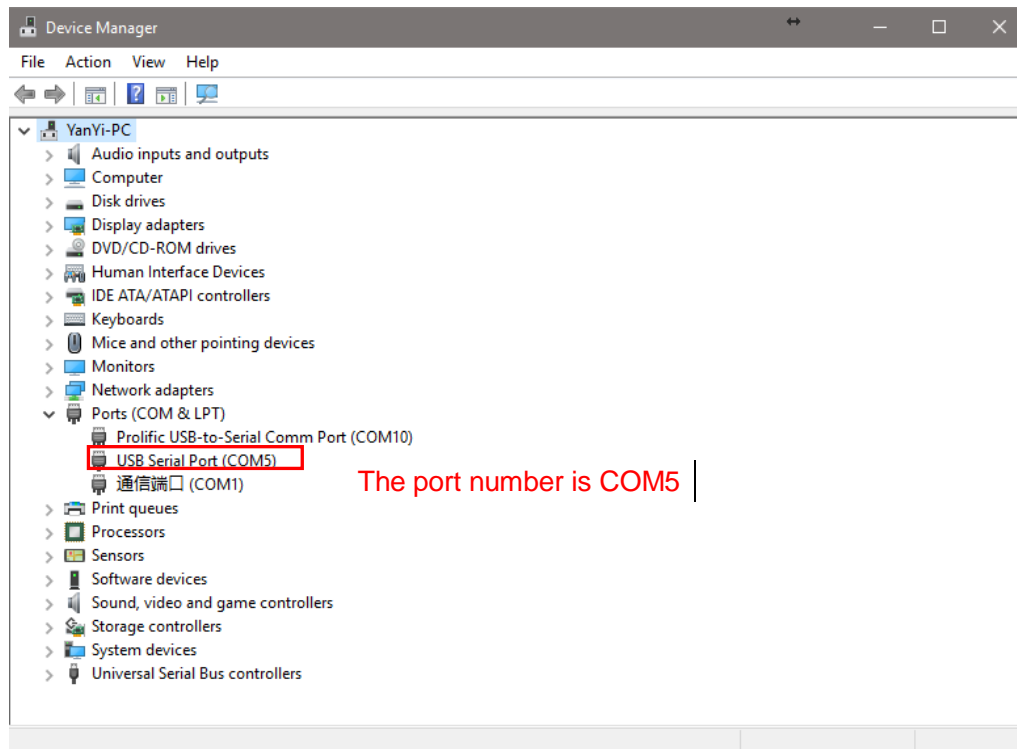

Fig.107 Check the port number at “Device Manager”

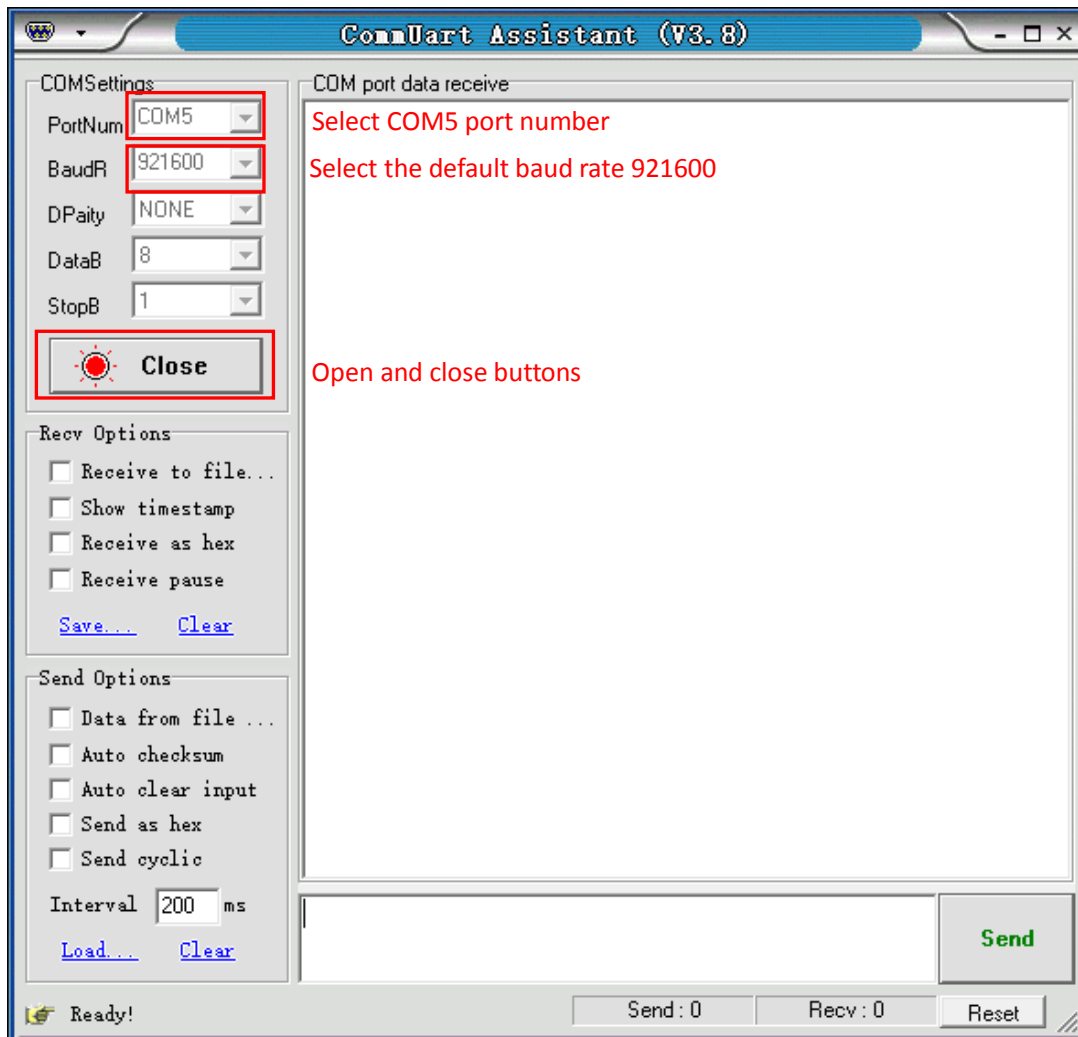

Fig.108 USB connection succeeds

4. Transfer commands to communicate with the OE1022.

1) The commands consist of four upper mnemonics, option parameters and a terminator. Several commands at the same line are separated by semicolons. More details please see Chapter 5 Remote Programming. The terminator can be a carriage return <cr> or a hexadecimal number 0D. When sending the command, first input the command in the sending area, then press the Enter key, then click the 'Send' button, the command will be sent. As shown in Fig.109 and Fig.110.

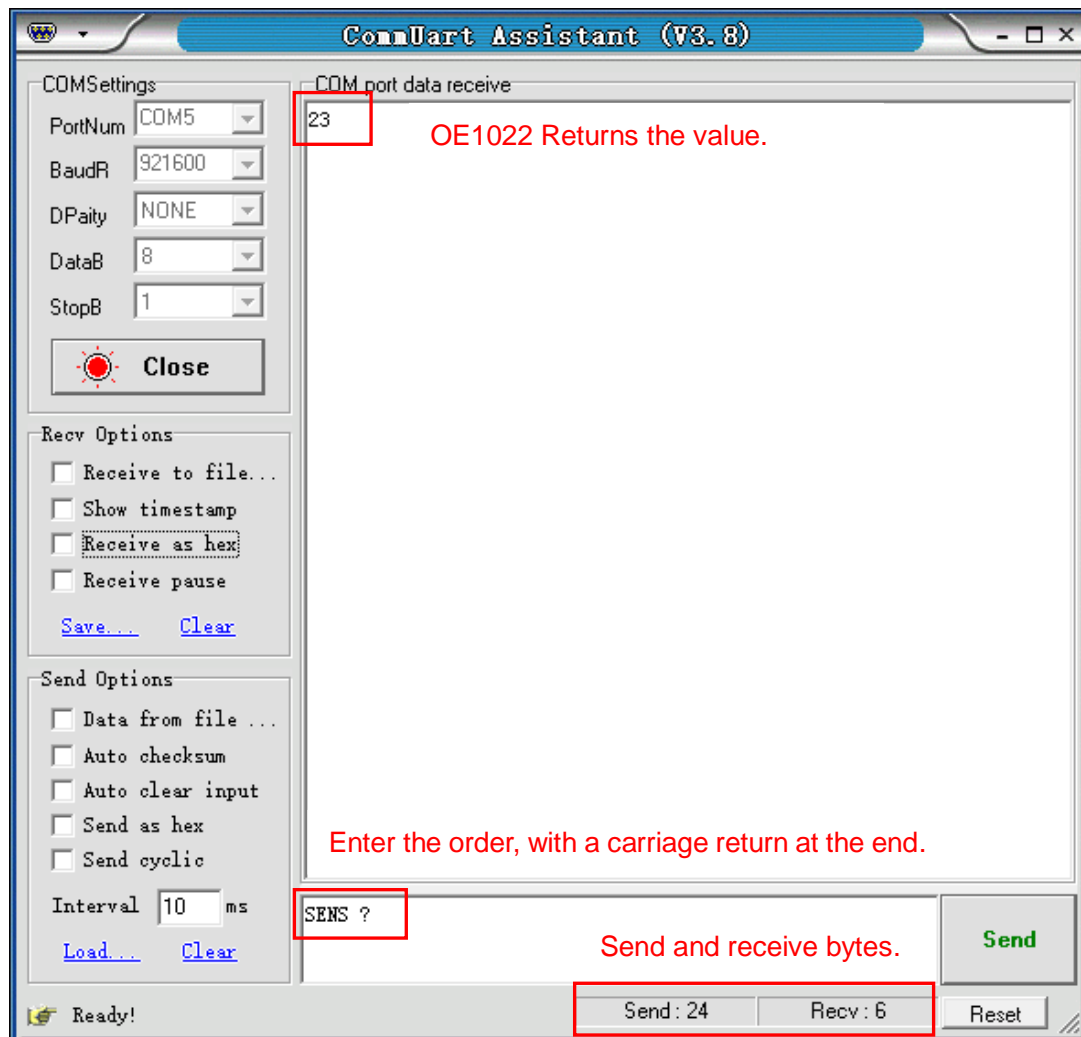

Fig.109 Send and receive commands in ASCII words

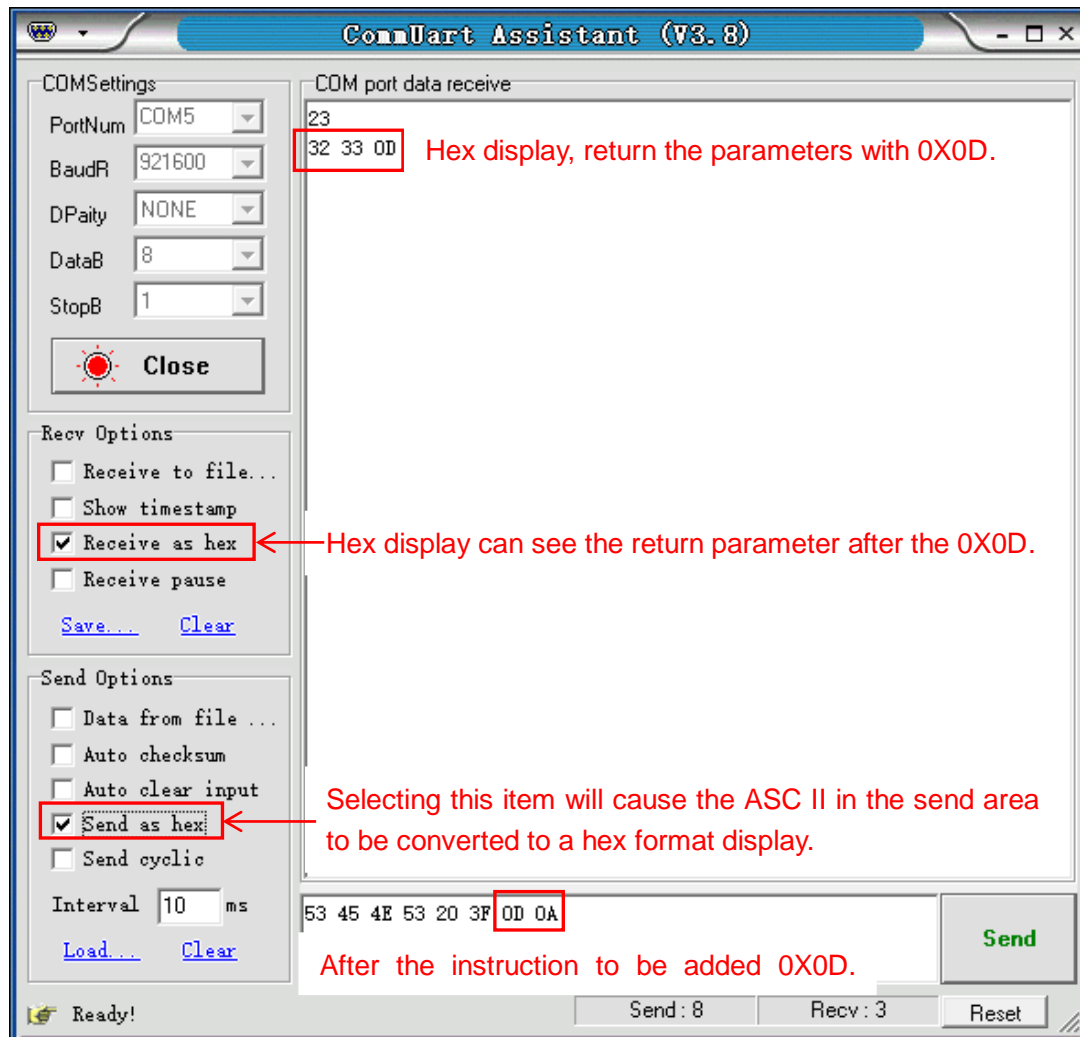

Fig.110 Send and receive commands in HEX

2) The serial assistant can be configured to automatically add carriage return 0X0D. You just need to click **Auto checksum:** and choose **Fixed Byte Checksum** . Finally, set the additional digit to <0D> as Fig.111.

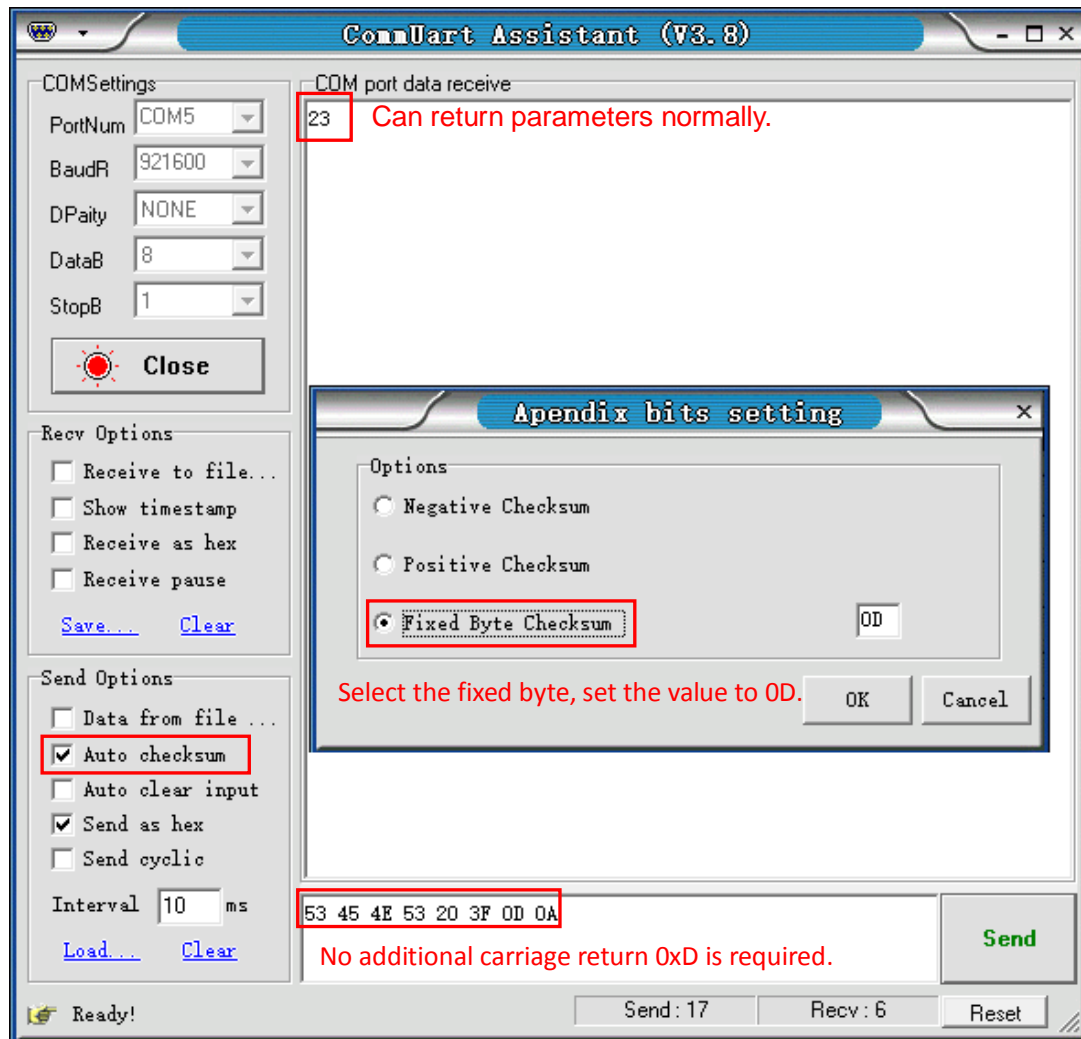

Fig.111 Setting the checksum

3) Multiple commands are separated by “;”, such as “SENS 24;FMOD 1;FREQ 1000;SENS ?;FMOD ?;FREQ ?”, as is shown in Fig.112.

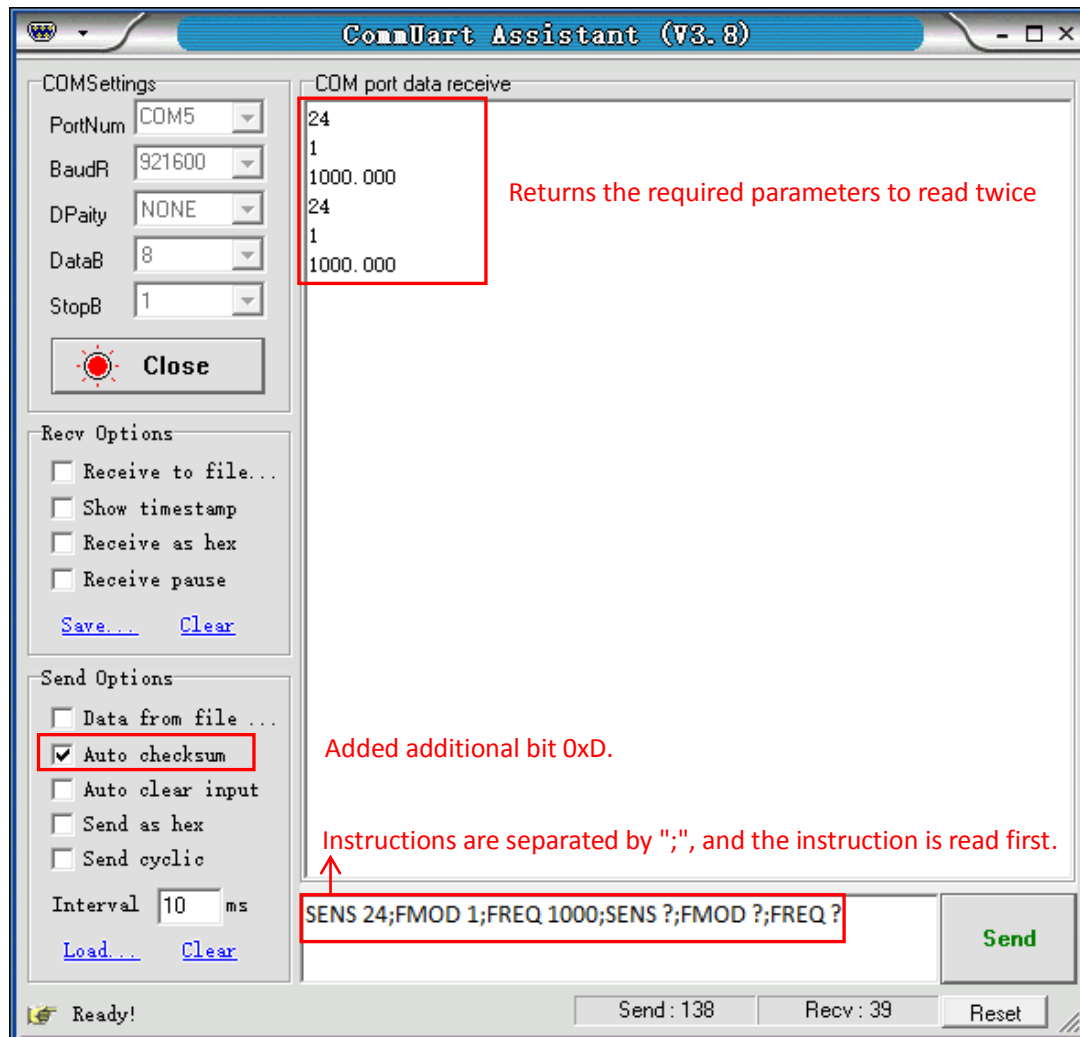

Fig.112 The execution of multiple commands

4) If you want to read the values of $\langle X \rangle$, $\langle Y \rangle$, $\langle R \rangle$, $\langle \theta \rangle$ and Freq continuously, you can set the transfer interval time as Fig.113 and Fig.114.

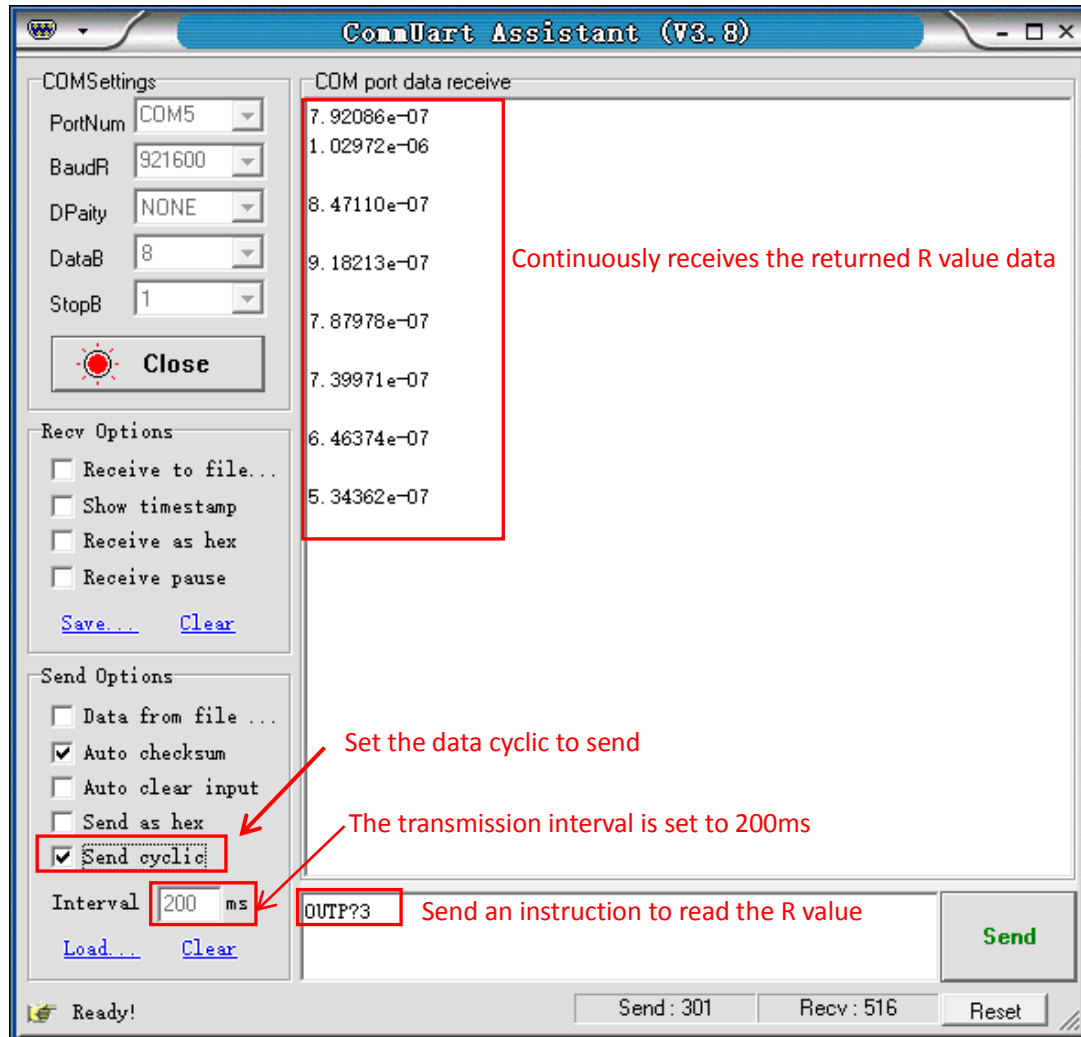

Fig.113 Read the single R value continuously

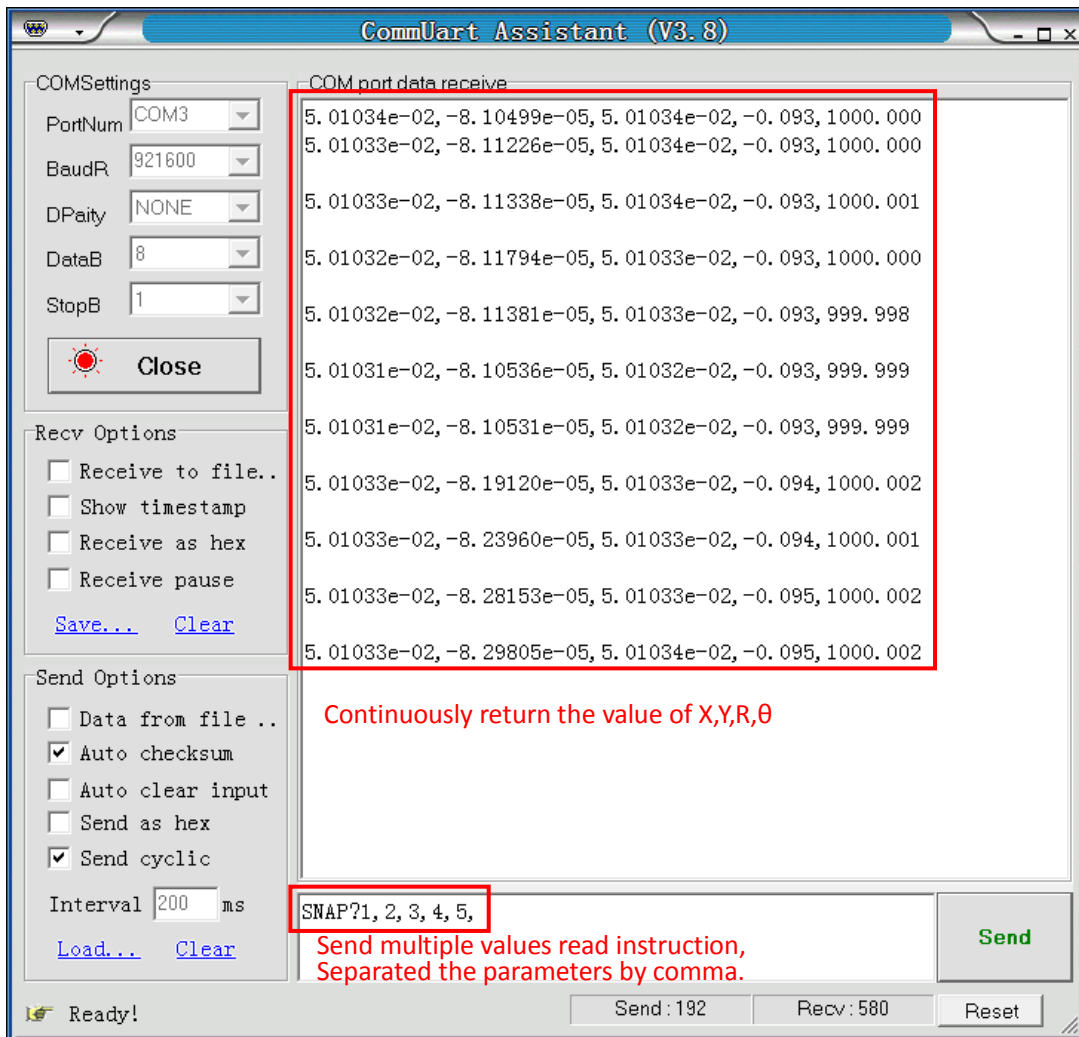

Fig.114 Read the Values of X, Y, R θ and Freq continuously

Note that when use this software to control the OE1022, the LCD display will refresh at the same time. For example, if <Sens: 100mV> is corresponding to the “25” command. <Sens> will change to <Sens: 50mV> when the OE1022 receives the “24” command.

The OE1022 can use many versions of serial debugging assistant. You can use other software to control the OE1022 remotely.